



## INSTALLATION, OPERATION AND MAINTENANCE MANUAL



### Air Curtains ZEN

*Please, read these instructions carefully before attempting installation*

#### SECURITY ADVISE SYMBOLS



*Attention, Danger, Safety Advice!*



*Danger from electric current or high voltage!*



*Injuries risk!*



*Danger! Do not stay underneath: Heavy load.*



*Important information.*

**AIRDOM05081-R13(14/04/16)**

## INDEX

CONNECTION DIAGRAM.....	3
INSTALLATION .....	4
Power Supply .....	4
PCBoard and Control.....	5
Fixing.....	5
Water coils .....	5
Electrical elements.....	5
STORAGE AND TRANSPORT .....	6
WORKING INSTRUCTIONS .....	6
Control PCBoard characteristics.....	6
Controller's common characteristics.....	6
Common characteristics to all controllers for water heated air curtains .....	7
Common characteristics to all controllers for electrical heated air curtains.....	7
Special controllers.....	8
Remote control characteristics.....	8
WIRING DIAGRAMS .....	8
DATASHEET .....	13
MAINTENANCE INSTRUCTIONS .....	15
External cleaning.....	15
Internal cleaning.....	15
REPAIRS AND REPLACEMENTS.....	15
Fan replacement .....	16
Fuse and PCB replacement.....	16
Heater replacement.....	17
FAILURES AND SOLUTIONS.....	19
ACCESSORIES.....	20
DECLARATION OF CONFORMITY.....	21
Air curtain identification.....	22
GUARANTEE .....	22

# CONNECTION DIAGRAM

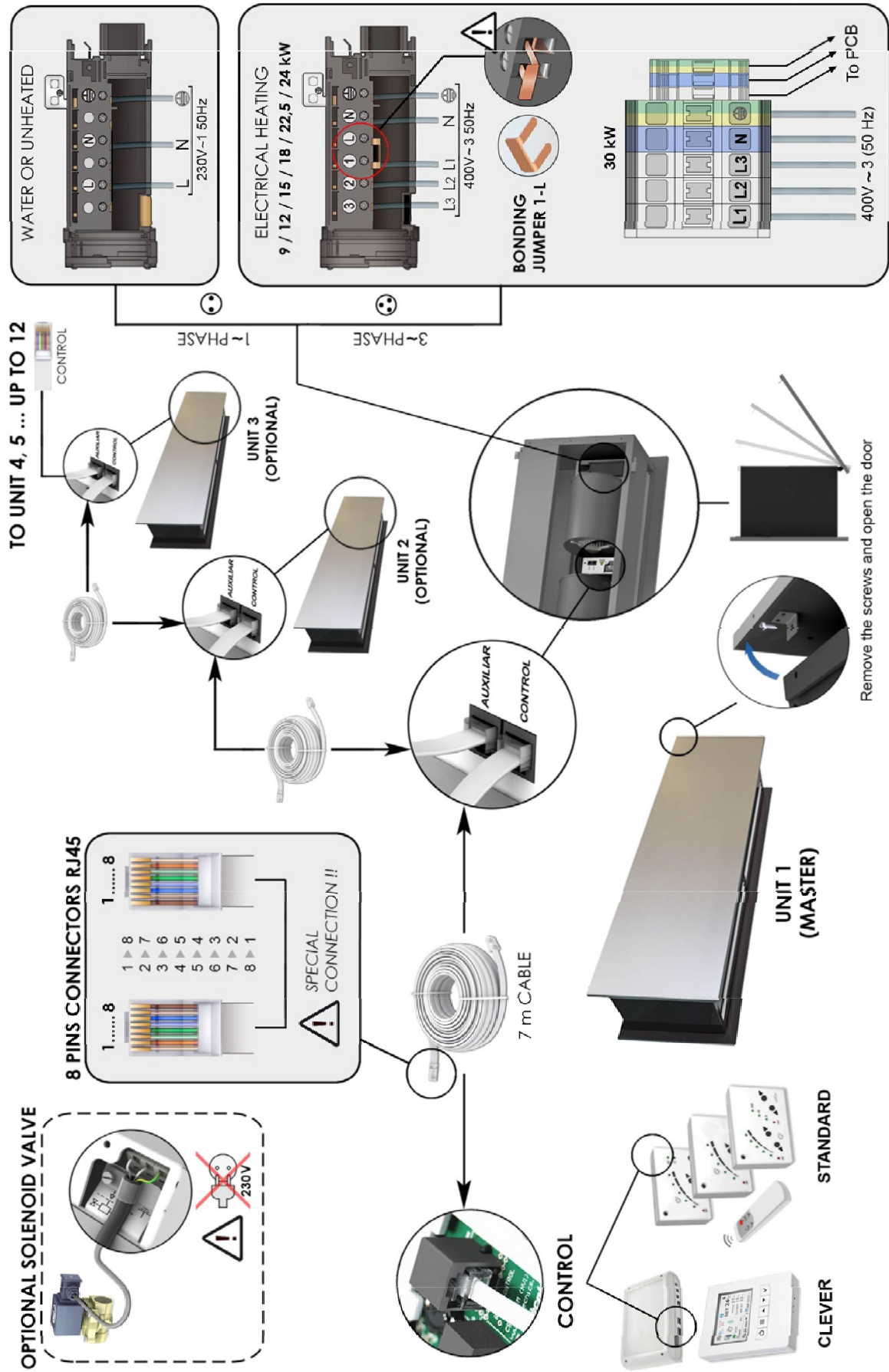

## INSTALLATION

Valid for models: **Zen**

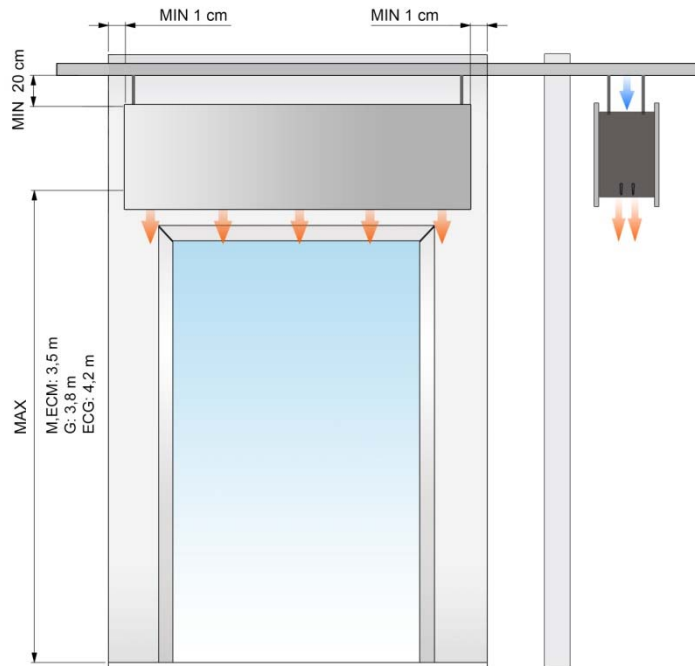

MAX. Maximum recommended height, MIN. Minimum recommended distance

(\*\*\*) Customizable panels

Minimum recommended distance between the inlet grille and any obstacle is of 200mm.

	<b><i>Installation work, connection, disconnection, electrical wiring, mechanical maintenance and service must be done by qualified people observing these instructions and in accordance with all applicable norms and standards. If the unit is operated with additional controller, please consider its specific instructions.</i></b>
	<b><i>It is necessary to open the air curtain to connect it because connections (power supply, control, water pipes when existing) are placed inside. Fixations are external. See how to open service door at repairs section.</i></b>
	<b><i>For safety, the air curtains never have to be stopped by disconnecting them from the main supply, always through the controller and waiting 10 minutes at least to disconnect the main supply. In case to not follow these instructions, the internal parts of the air curtain can be damaged.</i></b>

### **Power Supply**

To connect the power supply there is a black connection box outside the air curtain (located on top).

For an ambient air or water heated air curtain, just connect the single phase 230Vx1.

In case of an air curtain with electrical heating we will also connect the three phase 400Vx3 of the electrical element. Optionally under request the power supply of the water coil or electrical element can be three phase 230Vx3 or single phase 230Vx1 depending on each model (special wiring diagram will be enclosed).

## **PCBoard and Control**

---

To connect the controller there is a PCBoard (printed circuit) located inside the air curtain (if the air curtain has internal connections).

Open the unit to connect it (see how to open each model at *Repairs and Replacement*).

Use the 7 meters RJ45 cable supplied with the equipment. The communication between the controller and the PCB is digital and low-voltage.

Optionally, there are different accessories and controllers available, to meet every customer needs (Clever Control, thermostats, hand-auto, door contacts, anti-freezing sensor, supports, valves, etc.).

The new total control for ventilation technology is advanced *Clever* regulation. Leading the new generation of air curtains management with maximum control providing maximum energy saving. Clever automatically adapts the functioning of the air curtain to the entrance climatic conditions in order to keep the comfort and energy saving.

For more information ask for *Clever Control* manual.

## **Fixing**

---

Units are provided of several external suspension points, depending on the weight and length of each model (see exact situation of the points at the air curtains characteristics page).

Generally air curtains work horizontally but also can be installed vertically using feet supports (*Accessories* section).

The fixing of the air curtain should be managed according to the weights of each unit shown on the technical data page. The installation can be made through threaded rods, cable tensors or other supports. See available supports in the accessories section.

## **Water coils**

---

***Water heated air curtains have a PC Board with an output of 230Vx1 to install an electro valve (open/close water entrance) or any other device.***

It is recommended:

- Close the hot water circulation (by turning the electrovalve OFF) to avoid fan overheating while the unit is OFF. Electrovalve is optional.
- Install 2 cutoff water valves (supply and return) in order to disassemble the equipment easily.
- Install a bleeding valve at the highest part of the water heating circuit.

The ambient temperature should be always over +4°C, otherwise it will be necessary to provide an anti-frost protection device.

Water coils have a drainage point placed at the end part of the intake manifolds area.

Some special units are provided with condensation tray prepared to work with cold water. In this case, these units can't work at high ventilation speed (depending on model, length and power it will be a speed limitation). Intake air speed should not be higher than 3m/s because water drops can appear on the outlet.

## **Electrical elements**

---

The heater element has 9 resistances bars that combined give 2 stages of heating. The control is made by 3 PRBEO when power stage is less than 27kW or by contactors when it is higher than 30kW.

All electrical elements are protected electrically and electronically against overheating (see "*Operating instructions*" section).

The electrical controllers have the option to install an external thermostat that turns on/off the heating in order to control the temperature.

During the first uses scent can be emitted but it disappears in a few days.

## STORAGE AND TRANSPORT



**Attention! Heavy load.**  
**Do not step underneath hanging load during the transport or assembly.**

Store in a dry place and weather protected in its original packaging. In case the packing is opened, cover the air curtain to protect it from dust. Do not step or put heavy load over the package to avoid damages to the material. Store temperatures are between -20°C and +40°C.

When carrying material, make sure it is not damaged by the forklift (fork penetration in the packaging). Please see the *Packaging* instructions.

## WORKING INSTRUCTIONS



**For safety, the air curtains never have to be stopped by disconnecting them from the main supply, always through the controller and wait for 10 minutes at least to disconnect the main supply. In case to not follow these instructions, the internal parts of the air curtain can be damaged.**

### Control PCBoard characteristics

Fan speed is regulated through the input voltage variation of the fans set. The transformer has 5 output voltages: 120, 140, 170, 200 and 230 Volts.

### Controller's common characteristics

- **Controllers:** There are several models depending on the customer's needs (timers, anti-freezing detectors, thermostats, etc.).
- **5 ventilation speed.**
- **Memory:** When a power shortage happens, it guarantees that the selected speed will be maintained when the service is re-established. This function can be connected or disconnected through the switch ON/OFF placed inside the controller.
- **RJ45 cable and digital communication:** "Plug and Play" easy and fast connection through RJ45 cable and digital communication between the controller and the air curtain. This kind of communication is more reliable even at long distances.
- **External ON/OFF:** Inside the controller we can connect a normally open contact (1, 2) that controls the ON/OFF of the equipment through any external device, the contact is potential-free. When the contact is Open, the air curtain is ON. When the contact is closed the air curtain is OFF. It has a 30 seconds delay. It can be used with programmable timer, temperature sensors, fire alarms, PLC, etc.
- **Remote control:** All the standard controllers have an IR receiver that works by infrared.

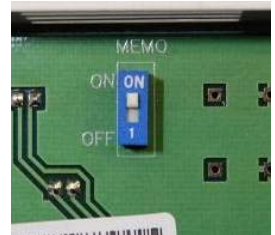

**Common characteristics to all controllers for water heated air curtains**



Unheated air curtain controller



Warm water heated air curtain controller

- **Heating ON/OFF:** It is possible to activate/deactivate the current of 230Vx1 to the electrovalve to open/close the water entrance to the coil. This 230Vx1 output connector is placed on top of the equipment, besides the telephone cable connection of the controller.
- **How to control an electro-valve with an external thermostat:** To control the inlet water to the battery through a thermostat, we must install it in series with the electro-valve. Thus, when it reaches the selected temperature, the electro-valve will close.
- **Safety thermostat:** If the internal temperature increases to 60°C and the first speed being selected, it automatically turns to the second ventilation speed. It will continue to the maximum speed till the internal temperature is lower than 50°C. The emergency operating is indicated by a flashing LED. If the safety activates too often the cause must be determined. The most probable is that we have to increase the cleaning of the inlet grill with more regular recurrence. For example, an obstruction in the inlet grill, the inactive motor or a too high ambient temperature in an installation with no ambient thermostat or a water temperature of the water coil over 80°C would increase automatically the speed fan. It also avoids that the expelled air by the air curtain is over 60°C (too high temperature sensation for people).

**Common characteristics to all controllers for electrical heated air curtains**

Equipment of five ventilation speed and three different heating powers (C1, C2, C3= [C1 + C2]).



- **3 Heating powers:** C1=1/3 Total, C2=2/3 Total, C3=C1+C2=Total.
- **Limited heating powers:** For safety reasons of the equipment, the heating power is limited by the ventilation speed that we had selected, the following way:
 

Selected speed	Max. heating power that can be selected
V1	Stage 1 heating.
V2	Stage 2 heating.
V3	Stage 2 heating.
V4	Stage 3 heating (stage 1 + stage 2).
V5	Stage 3 heating (stage 1 + stage 2).
- **Thermostat of delay:** When the equipment is stopped, and the heating has been working, there is an increase in temperature (by inertia) inside the equipment that could damage it. In order to avoid internal damages by overheating, when we stop the curtain and the internal temperature is over 50°C, there is a delay thermostat having the function to turn on again the fans automatically with maximum speed till the temperature goes under 50°C. This safety operating is indicated with a flashing green LED.

- **Safety thermostat:** When the air curtain operates with heating and the internal temperature increases over 60°C, a safety function activates: The air curtain increases one speed every two minutes till it reaches the maximum speed. After, it will start decreasing 1 heating stage till it stops. In case that after 2 minutes the situation persists, the heating will block. To unblock it, we must manually reset by disconnecting from the main supply. If in any moment the temperature decreases (below the set temperature) this process is interrupted and everything goes back to the normal situation.

A delay in the cleaning of the inlet grille or a high ambient temperature could temporally activate this function.

The air speed and the heating stage are indicated by a continuous lighted LED, while the safety function is indicated by a flashing LED. The blockage of the heating is indicated with the LED OFF of the heating flashing at a higher speed.

Auxiliary functions of the controllers with electrical heating:

- **Ambient thermostat (digital o analogue):** with an ambient thermostat we can turn on and off the heating when reaching a programmed temperature. Its use is specially recommended in closed areas of little dimensions because otherwise the temperature would increase too much. In case on installing the ambient thermostat, remove the bridge of the controller between terminal 4 and 5.

### Special controllers

If there is a will to control more parameters, there are two controllers that allow a lot more possibilities in comparison with the standard control, especially *Clever*. The following controllers have specific user manuals:

- Hand Auto
- Clever Control

### Remote control characteristics

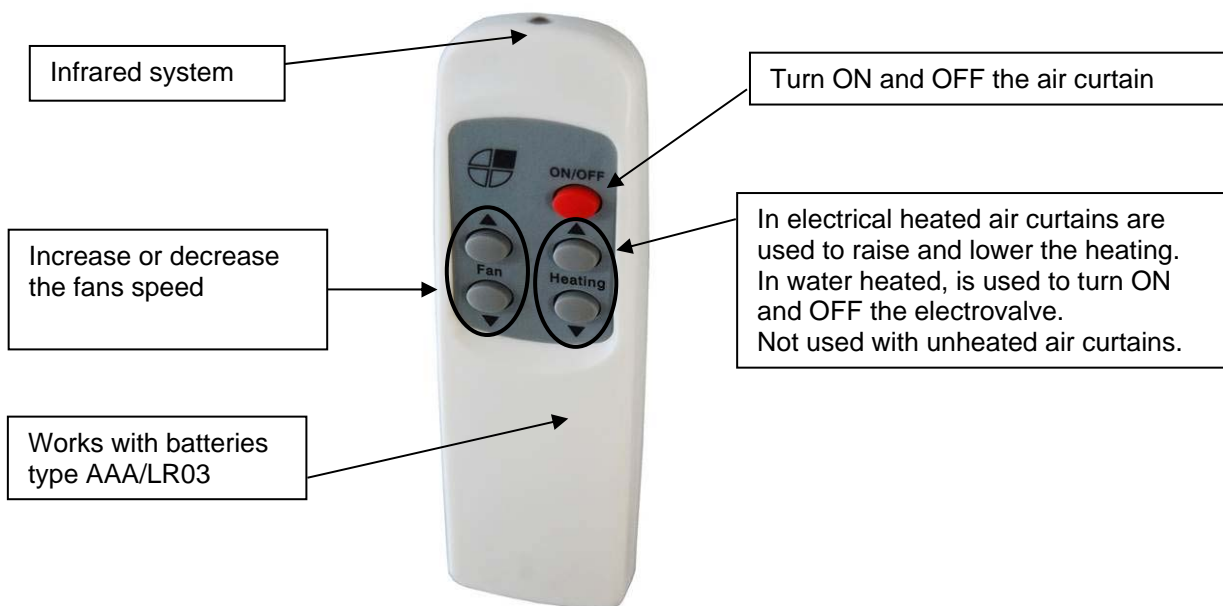

### WIRING DIAGRAMS

Following wiring diagrams are enclosed:

- Warm water heated or only air with standard controller. Diagram: AIRDOE09051
- Warm water heated with HC controller (Hand Auto, D805). Diagram: AIRDOE09251
- Electrical air curtain 30 kW with standard controller. Diagram: AIRDOE09101
- Electrical air curtain <27 kW PRBEO with standard controller. Diagram: AIRDOE09110

In case you need to connect the equipment to a PLC, the corresponding wiring diagrams will be supplied.



Reguladores de 5 velocidades  
5 Speeds remote Control

Control remoto  
Remote control

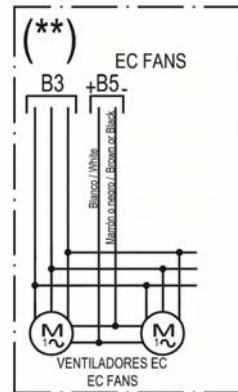
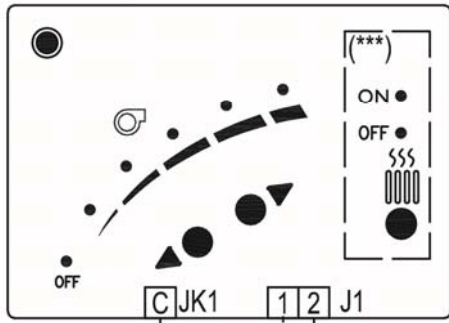

Marcha/Paro externo (opcional) 30 segundos de retardo  
ON/OFF Extern (optional) 30 Seconds Delay

Q = Interruptor magnetotérmico  
Q = Circuit breaker

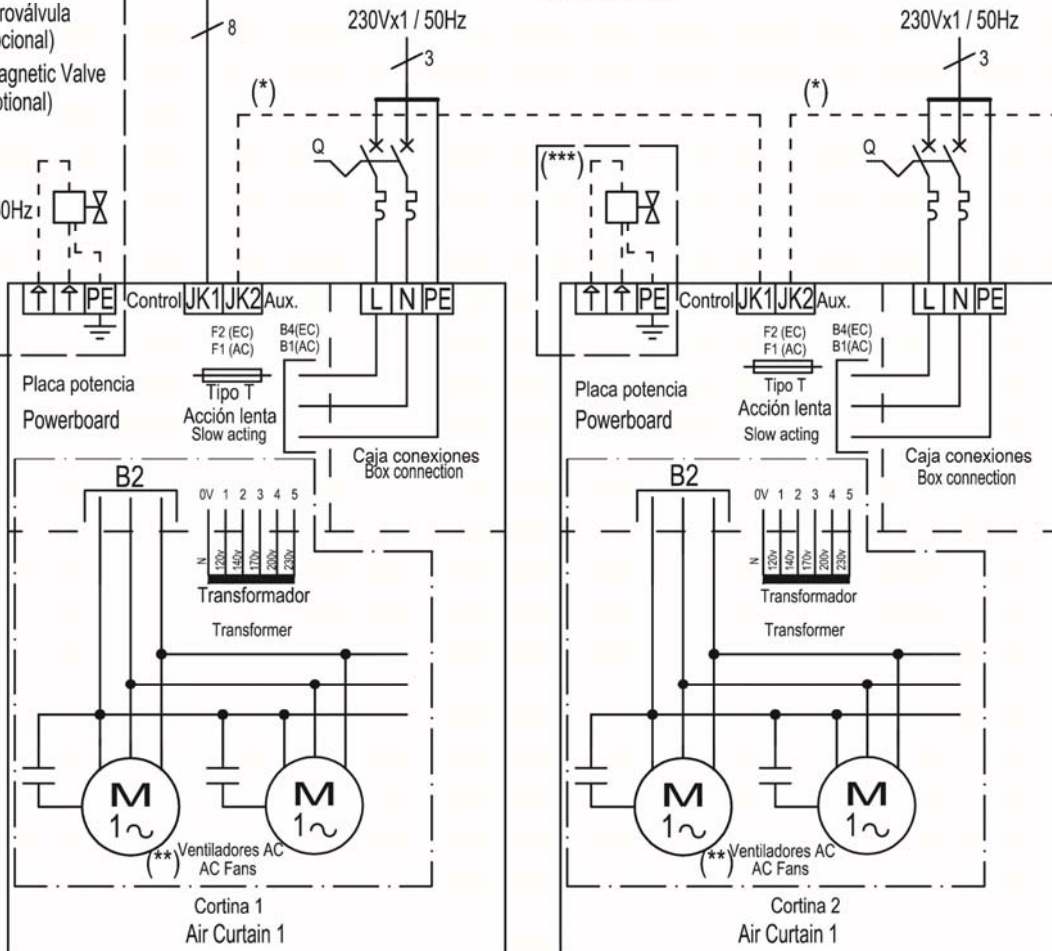
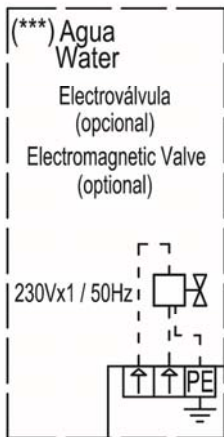

(\*) Cortina 2 (opcional, máximo 12)  
Air Curtain 2 (optional, Max 12)

ESQUEMAS ELÉCTRICOS CORTINA DE AIRE VENTILADORES AC/EC  
WIRING DIAGRAMS OF AIR CURTAIN AC/EC FANS  
CONTROLADOR 5 VELOCIDADES AGUA O AIRE M, ECM, G, ECG  
WATER AND ONLY AIR, CONTROLLER 5 SPEEDS. M, ECM, G, ECG

Pág./ Page 1 de/ of 1  
Doc. AIRDOE09051  
R12 - 17/02/16

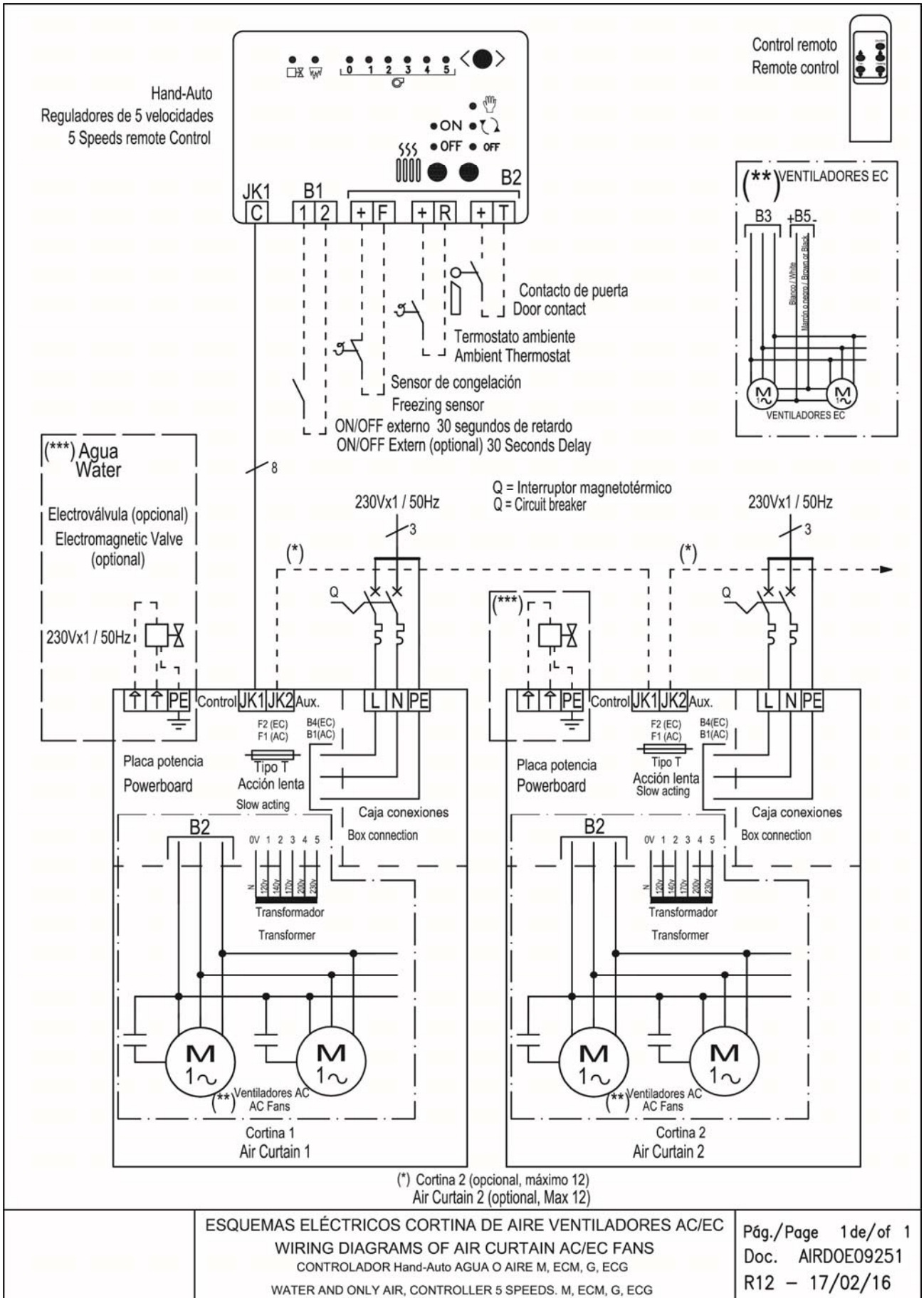

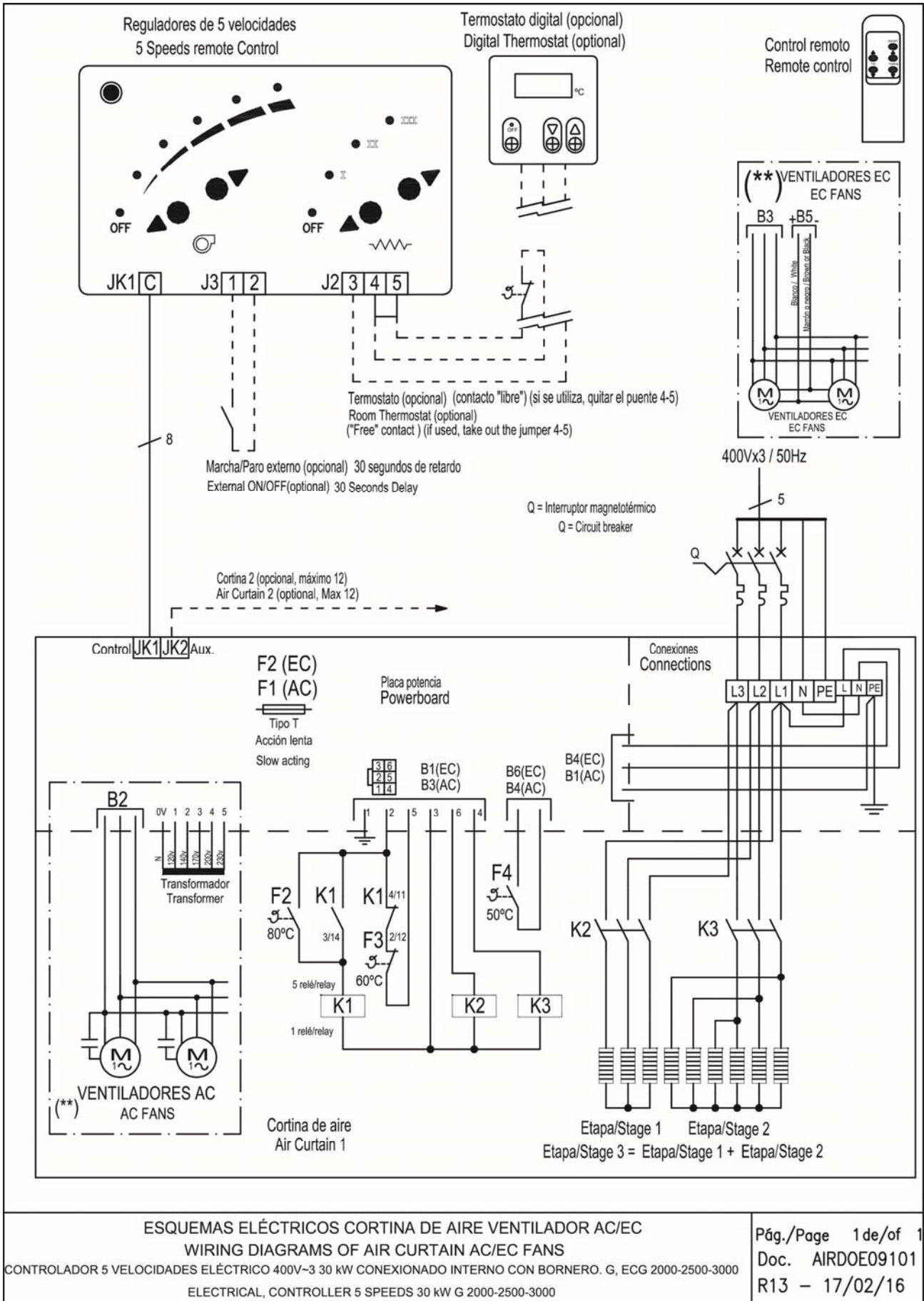

ESQUEMAS ELÉCTRICOS CORTINA DE AIRE VENTILADOR AC/EC  
WIRING DIAGRAMS OF AIR CURTAIN AC/EC FANS

CONTROLADOR 5 VELOCIDADES ELÉCTRICO 400V~3 30 kW CONEXIONADO INTERNO CON BORNERO. G, ECG 2000-2500-3000  
ELECTRICAL, CONTROLLER 5 SPEEDS 30 kW G 2000-2500-3000

Pág./Page 1 de/of 1  
Doc. AIRDOE09101  
R13 - 17/02/16

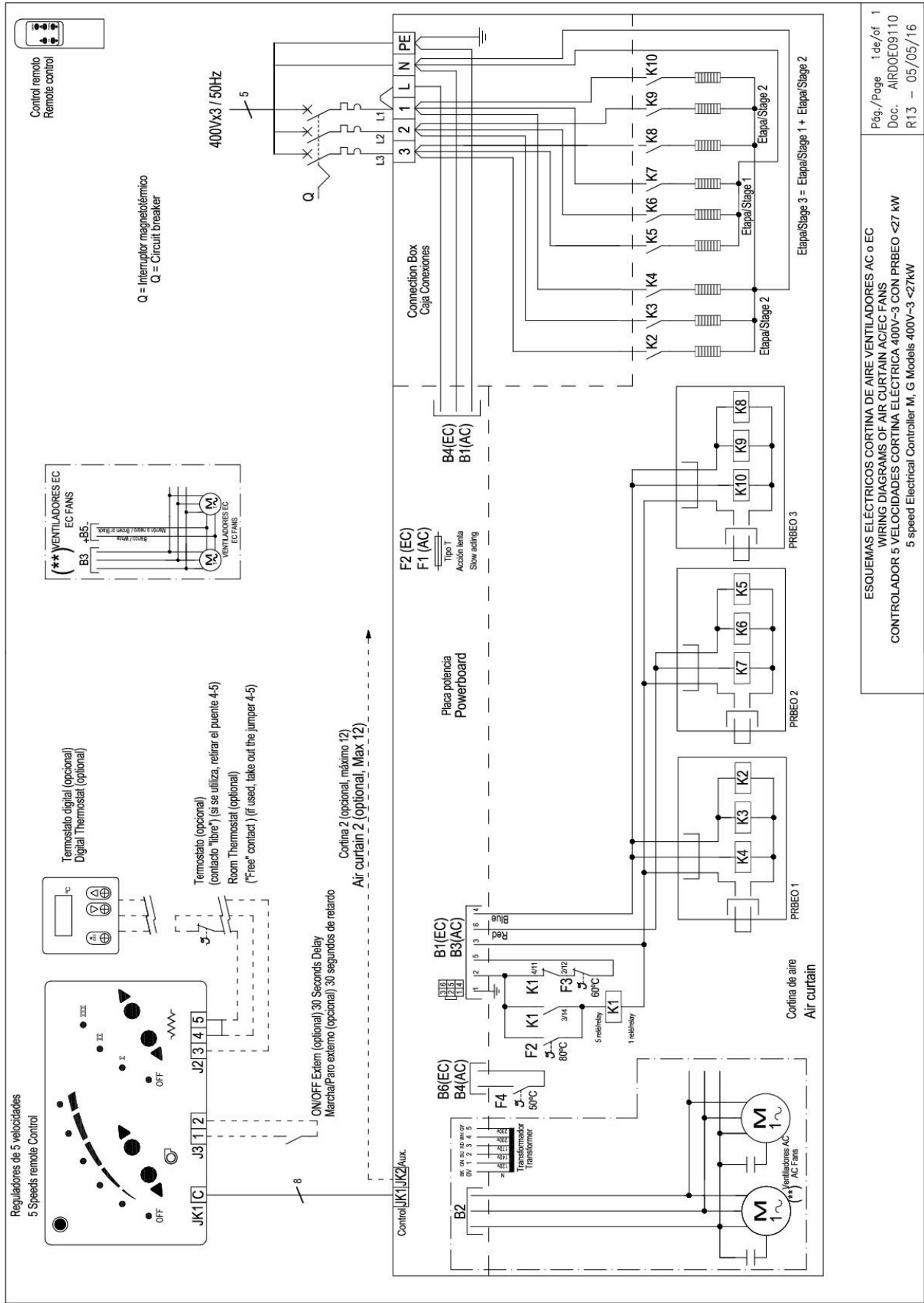

ESQUEMAS ELÉCTRICOS CORTINA DE AIRE VENTILADORES AC o EC  
 WIRING DIAGRAMS OF AIR CURTAIN AC/EC FANS  
 CONTROLADOR 5 VELOCIDADES CORTINA ELÉCTRICA 400V-3 CON PRBEO <27 kW  
 5 speed Electrical Controller M, G Models 400V-3 <27kW

ZEN | Decorative Air Curtains For Commercial Doors



Characteristics



- Decorative air curtain in contemporary architectural style. Its minimalist and smart design integrates in any environment and offers infinite options to customize.
- Can include personalized logotypes, signs or graphic designs. It can even incorporate clocks or lighting.
- Front anodized aluminium panels. Optionally manufactured in brushed or mirror polished stainless steel. Other materials are possible, such as wood, metal, etc.
- Central structure made of galvanized steel finished in black forge as standard. Other colours are available on request.
- Anodized aluminium outlet vanes, airfoil shaped, adjustable in both directions.
- Double-inlet centrifugal fans driven by an external rotor motor and low noise level. 5-speed selector. "EC" models assembled with very low consumption efficiency fans.
- "P" type with water heated coil. "E" type with electrical shielded elements, three stages with integrated regulation. "A" type without heating, air only. Optional expansion DX coil.
- Includes Plug&Play control with 7m RJ45 cable and infrared remote control. Optional: Clever control (programmable, automatic, intelligent, energy saving, Modbus RTU for BMS...).

Specifications

AIR ONLY

Model	Airflow m³/h	Power Fans 230V-50Hz kW	Current Fans 230V-50Hz A	Noise Level (5 m) dB(A)	Weight kg
ZEN M 1000 A	1980	0,318	1,41	55	32
ZEN M 1500 A	2640	0,424	1,88	56	46
ZEN M 2000 A	3960	0,636	2,82	57	62
ZEN M 2500 A	4620	0,742	3,29	58	75
ZEN G 1000 A	2400	0,642	2,85	57	36
ZEN G 1500 A	3200	0,856	3,80	58	50
ZEN G 2000 A	4800	1,284	5,70	59	69
ZEN G 2500 A	5600	1,498	6,65	60	83
ZEN ECG 1000 A	2700	0,225	1,95	61	36
ZEN ECG 1500 A	3600	0,300	2,60	62	50
ZEN ECG 2000 A	5400	0,450	3,90	63	69
ZEN ECG 2500 A	6300	0,525	4,55	64	83

ELECTRICAL HEATED

Model	Airflow m³/h	Electrical Heating Capacity 400Vx3-50Hz kW	Power Fans 230V-50Hz kW	Current Fans 230V-50Hz A	Noise Level (5 m) dB(A)	Weight kg
ZEN M 1000 E	1980	3,6/9	0,318	1,41	55	40
ZEN M 1500 E	2640	4,8/12	0,424	1,88	56	58
ZEN M 2000 E	3960	6,1/2/18	0,636	2,82	57	77
ZEN M 2500 E	4620	6,1/2/18	0,742	3,29	58	94
ZEN G 1000 E	2400	5,1/10/15	0,642	2,85	57	43
ZEN G 1500 E	3200	7,5/15/22,5	0,856	3,80	58	62
ZEN G 2000 E	4800	10,2/20/30	1,284	5,70	59	85
ZEN G 2500 E	5600	10,2/20/30	1,498	6,65	60	103
ZEN ECG 1000 E	2700	5,1/10/15	0,225	1,95	61	43
ZEN ECG 1500 E	3600	7,5/15/22,5	0,300	2,60	62	62
ZEN ECG 2000 E	5400	10,2/20/30	0,450	3,90	63	85
ZEN ECG 2500 E	6300	10,2/20/30	0,525	4,55	64	103

WATER HEATED

Model	Airflow m³/h	P86		P64		P54		Power Fans 230V-50Hz kW	Current Fans 230V-50Hz A	Noise Level (5 m) dB(A)	Weight kg
		Heating Capacity 80/60°C kW	Water Drop Pressure 80/60°C Pa	Heating Capacity 60/40°C kW	Water Drop Pressure 60/40°C Pa	Heating Capacity 50/40°C kW	Water Drop Pressure 50/40°C Pa				
ZEN M 1000 P	1860	9,84	1000	9,22	4990	-	-	0,318	1,41	55	37
ZEN M 1500 P	2480	14,23	760	13,65	6430	-	-	0,424	1,88	56	53
ZEN M 2000 P	3720	22,17	2190	19,70	5470	-	-	0,636	2,82	57	71
ZEN M 2500 P	4340	27,69	4000	23,48	4060	-	-	0,742	3,29	58	86
ZEN G 1000 P	2250	11,04	1230	10,42	6190	10,56	1790	0,642	2,85	57	40
ZEN G 1500 P	3000	16,02	940	15,47	8020	16,37	5670	0,856	3,80	58	57
ZEN G 2000 P	4500	24,92	2700	22,29	6810	23,15	3030	1,284	5,70	59	78
ZEN G 2500 P	5250	31,16	4930	26,61	5060	28,76	5450	1,498	6,65	60	96
ZEN ECG 1000 P	2550	11,89	1400	11,27	7110	11,50	2090	0,225	1,95	61	40
ZEN ECG 1500 P	3400	17,29	1070	16,77	9240	17,86	6620	0,300	2,60	62	57
ZEN ECG 2000 P	5100	26,86	3080	24,14	7850	25,24	3530	0,450	3,90	63	78
ZEN ECG 2500 P	5950	33,63	5650	28,84	5840	31,38	6360	0,525	4,55	64	95

Water heated: connection pipes P86 and P64 are 2x3/4" female (male if lateral pipes), P54 2x1" male. P86 2 rows coil, P64 3 rows coil, P54 4 rows coil.



**Dimensions**

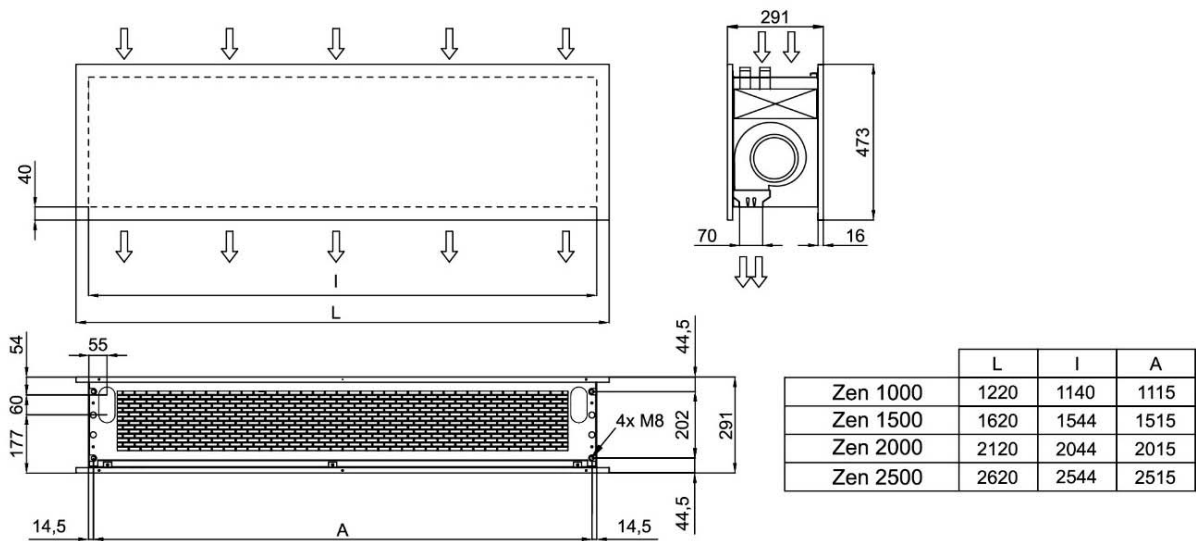

**Finishes**





Examples of customized front panels, to meet client needs



- Painted any RAL colour or metal
- Different materials: Aluminium, stainless steel AISI 304 (brushed or polished), wood, glass, PVC/PES, etc.
- Logos, lights, clocks, signs, vinyls, patterns, etc.

## MAINTENANCE INSTRUCTIONS

	<b><i>For safety, before any cleaning, disconnect power supply using the controller.</i></b>
	<b><i>It is forbidden to open the service door (risk of electrical discharge and being trapped in fans). Service and maintenance should be done only by introduced and qualified workers.</i></b>
	<b><i>Do not use water or steam for cleaning the internal parts and components of the air curtain.</i></b>

### ***External cleaning***

Air curtains don't need any kind of maintenance except from the cleaning of the casing and the inlet grille. It is recommended to weekly clean the inlet grille. It's important to make sure that the air curtain is OFF, otherwise the dust mixed with a wet cloth would create a kind of paste that will damage the fan rotor when it sucks the air.

Annual cleaning of the discharge area (outlet).

The casing of the air curtain should be cleaned with a wet cloth and non-aggressive detergent. Do not use caustic soap or acids.

The inlet grille prevents the settling of dust and strange objects in the internal elements. It is recommended to check periodically that the inlet grille is free of any object that could interfere the air entrance (plastic bags, papers, etc.).





### ***Internal cleaning***

In models without micro drilled inlet grille and water coil or electrical heating is recommended to clean the inside of the unit with a vacuum at least once a year (\*), best before the winter season, with qualified staff.

(\*) These periods are indicative, depending on the ambient conditions of every installation.

In places with a high number of particles in suspension is desirable to increase the frequency of the internal cleaning (including the city centers, near construction sites, etc.).

## REPAIRS AND REPLACEMENTS

	<b><i>Installation and electrical connections must be done by qualified workers and following these instructions.</i></b>
	
	
<b><i>Before any repairs are undertaken, please:</i></b>	
<ul style="list-style-type: none"> <li>• <b><i>Inform people that there is work in progress.</i></b></li> <li>• <b><i>Disconnect the power supply and protect the thermal magnet (so nobody can restart it accidentally).</i></b></li> <li>• <b><i>Make sure there is no tension in the air curtain.</i></b></li> <li>• <b><i>Make sure the fans are stopped.</i></b></li> <li>• <b><i>Use only original spare parts.</i></b></li> </ul>	

To **open the service door**, follow these steps:

1.- With a screwdriver and holding the service panel, remove the screws that fix it, placed on the top of the air curtain.



2.- Open the door carefully, in case you need to dismount it, remove the safety cables and move the door to one side to make it come out of position.



Some finishes can be fragile, manipulate the door gently and project it.

---

### ***Fan replacement***

Before replacing the fan, inform people that there is work in progress, stop the air curtain through the controller and disconnect main supply. Make sure that the unit is without tension and the fans are stationary. Unplug the fan from the cable tree. Remove the fan by loosening the fixing screws and assemble the new fan following the process in reverse order.



---

### ***Fuse and PCB replacement***

Before the replacement, inform people that there is work in progress.

**Disconnect main supply**, make sure that the unit is without tension and that the fans are stationary.

**Fuse replacement:** Open the service panel and remove the fuse of the fuse holder by hand or pulling with the help of a screwdriver pressing to the plate and turning in under clockwise, then replace it.





**PCB replacement:** Open the service panel and simply unscrew the power plate from the inside of the air curtain to remove it and make the necessary repairs.



### Heater replacement

Before the replacement, inform people that there is work in progress, disconnect main supply, make sure that the unit is without tension and that the fans are stopped. Before proceeding to unfasten the heater fixing screws, we must:

**Water Coils:** Close the shut-off water valves of the building water circuit to the air curtain (supply and return). Open the service door and empty the water from the coil simply removing the draining screw placed in the bottom of the entrance manifold as shown in the photograph.



**Electrical Heaters:** Disconnect the power supply from the electrical element.

When we have the coil or heater ready, we proceed to remove the fixation screws to disassemble the coil or heater and assemble the new heater following the same process in reverse order.



Remove the screw-earth of the connection box and disassemble from the equipment.



Unplug the cables to 1, 2, 3 in the connection box.



Unplug the two connectors of plate pressing the fluke.

Open the service door, remove the screws of the water coil or electrical heater and remove it

After opening the service door, we proceed to remove the heater according to the following steps. First, extract the rubber caps and remove all screws which fasten the inlet grille. Now you can remove the grille.



Then, unscrew all the screws from the selected support according to the pictures



Afterwards, unfasten the 2 side covers. In case of vertical installation, you must remove 1 side cover and the foot support.

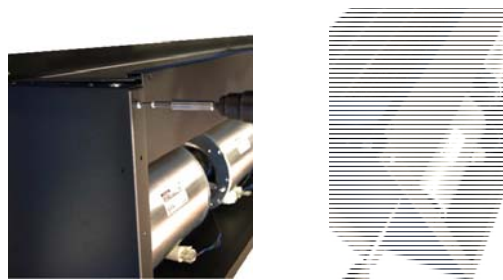

For ZEN 2000 and 2500 models, you also have to loosen the middle reinforcement rod support.



To end, the heater is fastened by these little angles. Once unscrewed, we can extract the heater. Now, we can do the repairing or replacing the heater following the reverse process.



Loosen and rotate all the flukes that hold the coil or heater.

## FAILURES AND SOLUTIONS

**More than 95%** of the complaints are submitted during the start of operation of the equipment and are due to installations errors.

More than 90% of the failures are solved only by **checking the connections**. Following the three following points, we can make sure that the installation is correct:

**A) RJ45 cable manipulated:** The cable that connects the controller to the air curtains is an 8 lines crossed RJ45 cable. **If manipulated (cut or removed the connector) and incorrectly joined (reverse way) the air curtain will not work well.** Moreover it can damage the electronics. To solve the problem just turn the connector of the cable (see connection diagram in the first page).

**B) Wrong connection of the RJ45 cable.** Verify whether the connector position is the correct, between the “control” and “auxiliary”, according to the installation diagram (particularly if there are several air curtains with a single controller).

**C) Wrong current supply/input.** The air curtain input depends on the type of current available and also on the heating type of the unit. Connect the unit according to the connection diagrams of the first page.

More common failures and solutions		
Effect	Problems	Solutions
<b>All lights of the controller are OFF</b>	Is the RJ45 cable the original (not manipulated), with no enlargements either shortenings?	Change the cable or connect it again correctly.
	Does the current reaches the connection box?	Connect correctly the terminals of the junction box: Between L and N there must be 230V and if the air curtain goes with three-phase electrical element, there must be 400V among terminals L1, L2 and L3.
	Is the controller connected to the air curtain, to the connector “Control” of the PCBoard?	Connect the cable from the controller to the “Control”, never to the “Aux”.
	Is the fuse of the PCBoard in good conditions?	Check the fuse and replace it in case it is necessary (type T, slow action).
<b>Some lights of the controller are Flashing.</b>	The green LED of the maximum speed flashes when we stop the air curtain after having been operating with heating.	It is not a failure, but a safety mechanism. The air curtain turns on by itself to the maximum speed to get cold and protect its components. When it decreases from the safety temperature, it will stop.
	Some speed or heating lights are flashing when the air curtain is working.	It is a protection mechanism of the air curtain so that the internal parts of the air curtain do not suffer damages. Situations on which the problem continuously recurs and the way to solve it: 1. Inlet grille blocked (objects, dirtiness...) the ambient temperature inside the equipment can increase a lot if the air cannot circulate. Clean the grille. 2. Small room: we recommend installing a thermostat to control the heating power so the protection device do not activates. 3. In case that the ambient temperature is already high, we recommend to lower the power heating or install a thermostat. 4. Inlet air already warm, that comes from another heating equipment beyond the air curtain. Move the air curtain away, place a thermostat in the inlet part of the curtain or lower the heating power. 5. Any motor does not work: call the technical service.
<b>The heating does not work</b>	Does the three-phase current reach the connections box?	Check installation.
<b>The speed and/or the heat changes continuously with no apparent reason but the lights of the controller are not flashing.</b>	Probably the RJ45 cable is near interference sources, transmitters, cable plates, particularly those that supply current to Motors, etc.	Pass the cable the furthest possible away from interference sources, particularly when long distances or use a screened table.

## ACCESSORIES



### Clever Control

Intelligent proactive regulation, advanced functions, Automatic/manual working, door delay, timer, save energy program, multi equipment management, BMS Modbus connection, etc.



### External temperature Sensor

It permits to take the temperature from a place different to the control.



### Interface II

Allows the connection to a centralized management system (BMS, PLC, etc.).

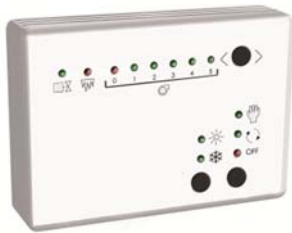

### Hand Auto 5 Speed (water heated)

It permits to connect anti-freezing sensors, door contact, ambient thermostat, etc.



### Ambient Thermostat

It limits the operating of the heating to the selected one.

Supports, feet, vibration dampers, etc. depending on the model.

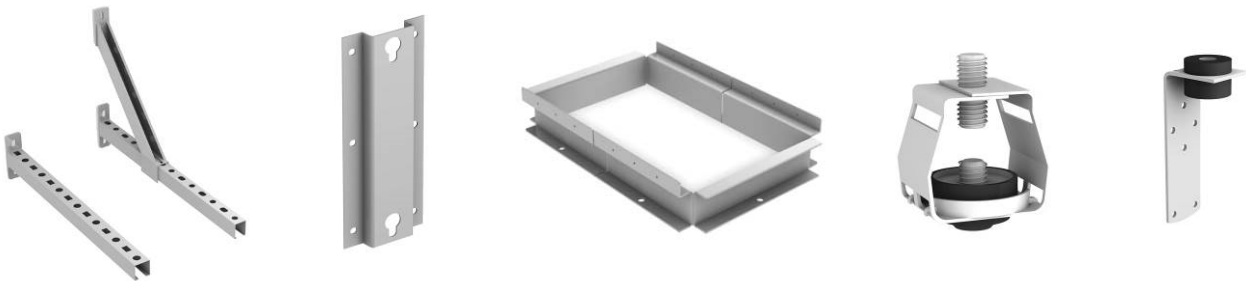

Door contact, thermostatic valve, solenoid valve, antifreezing sensor, etc.



RJ45 Cable 20m and 50m



Plenum and/or inlet/outlet kit (depending on the model)



DECLARATION OF CONFORMITY



Declaration **CE** of conformity / Declaración **CE** de conformidad

Manufacturer **Motors i Ventiladors S.L. (AIRTÈCNICS)**  
Fabricante **Conca de Barberà 6, Pol. Ind. Pla de la Bruguera  
08211 Castellar del Vallès (Barcelona) Spain**

We declare, under our sole responsibility, that the product(s)  
*Declaramos, bajo nuestra única responsabilidad, que el/los producto(s)*

**Air Curtains**  
**Cortinas de aire**

with models  
*con los modelos*

**Minibel, Optima, Recessed Optima, Windbox, Recessed Windbox, Smart,  
Dam, Deco, Kool, Variwind, Rotowind, Invisair, Rund, Zen, Duojet, Triojet,  
Max, Recessed Dam, Recessed Compact, Maxwell**

is/are developed, designed and manufactured in accordance with the following directive(s)  
*ha(n) sido desarrollado(s), diseñado(s) y fabricado(s) de acuerdo con la(s) siguiente(s) directiva(s)*

**Low Voltage Directive 2014/35/UE**  
**Directiva Baja Tensión 2014/35/UE**

**Electromagnetic Compatibility Directive 2014/30/UE**  
**Directiva Compatibilidad Electromagnética 2014/30/UE**

**Restriction Certain Hazardous Substances Directive 2011/65/EU (RoHS)**  
**Directiva Restricción Substancias Peligrosas 2011/65/EU**

**Eco-design Energy-related Products Directive 2009/125/EC**  
**Directiva Diseño Ecológico Productos Con Energía 2009/125/CE**

applying the following harmonized standards in particular  
*aplicando las siguientes normas armonizadas en particular*

**LVD: EN 60335-1:2012 + AC:2014 + A11:2014  
EN 60335-2-30:2010 + A11:2012**

**EMC: EN 61000-6-2:2006  
EN 61000-6-3:2007 + A1:2012  
EN 55014-1:2008 + A1:2009 + A2:2012  
EN 55014-2:2015**

**RoHS: EN 50581:2012**

Date / Fecha  
Name / Nombre  
Position / Cargo

**03/05/2016**  
**Jordi Oltra Orta**  
**General Manager / Director General**





<b>Model</b> <i>Modelo</i>	WINDBOX M 2000 E			
<b>Airflow</b> <i>Caudal</i>	3600	m3/h		
<b>Blowers</b> <i>Ventiladores</i>	1,88	A	0,424	kW 230 V/50Hz
<b>Heating capacity</b> <i>Calefacción</i>	80/60 °C		60/40 °C	
<b>Water Coil</b> <i>Agua</i>		kW		kW
<b>Electric Coil</b> <i>Batería Eléctrica</i>	6/12/18	kW	400V~3 50Hz	
<b>Serial Number</b> <i>Número de Serie</i>	2015-07-06 / 61.990			

### Air curtain identification

Each air curtain is identified by a unique serial number printed in a label located inside the door service. There is also indicated the model and their technical characteristics (flow, fans technical characteristics and power heating).

It is indispensable to have this number to facilitate possible replacements or technical information of the air curtain in question.

If you detect some error in this manual, we'll be pleased to receive your *feedback*, it helps us to improve even more.

Airtècnics reserves the right to modify some of the specifications in this manual.

## GUARANTEE

Your air curtain is guaranteed for a period of one year from the date of purchase. We will adjust, repair or replace at our discretion from our warehouse any defect, system failure or part found to be defective. The assembly cost out of our warehouse is at buyer expense. The products that, in our eyes, have been inadequately used, incorrectly manipulated, improperly installed, connected to different nominal tensions, modified, repaired by non-authorized workers or that have suffered damages during transport are totally excluded from the guarantee.

*To validate the guarantee it should be correctly filled and enclosed with the invoice that vouches for the buying date. If it is manipulated, it will lose all validity.*

*It is the buyer's responsibility to take the necessary safety measures because in case of a failure or mistake in one of our products, no damages to third parties, sets or installations will occur.*

✂ -----

### Guarantee draft

**Air curtains data:**

Model: ..... Series number: .....  
 Invoice date: ..... Invoice number: .....

**Buyer data:**

Name: .....  
 Address: .....  
 Country: ..... Phone: ..... Fax: .....

**Seller data:**

Name: .....  
 Address: .....  
 Country: ..... Phone: ..... Fax: .....

**Buyer signature and stamp**

**Seller signature and stamp**