

Note that all unique customer requirements (i.e tolerance) need to be verified thru Alfa Laval.

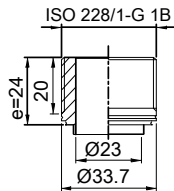

B 21
Alloy 316
S1,S2,S3,S4

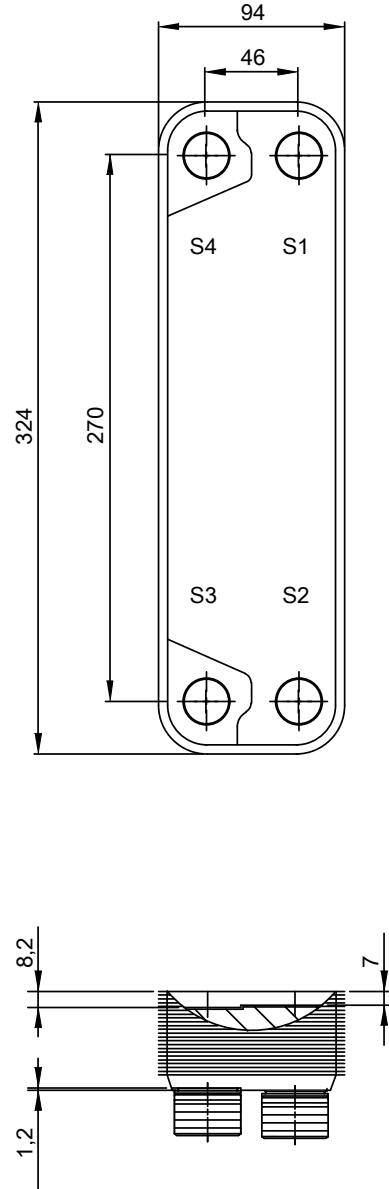
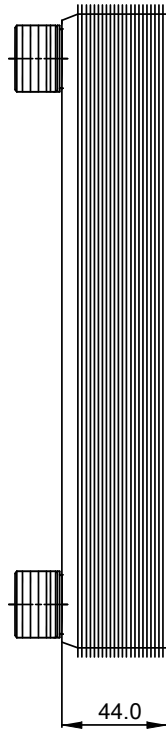

HEATING SURFACE
NETWEIGHT 3.08 kg
OPERATING WEIGHT
PLATE MATERIAL Alloy 316
PLATE GROUPING 1*11H/1*12H

Frameplate is depressed 1.2 mm at connection S3/S4
Pressureplate is depressed 1.2 mm / even number of channel
plates at connections T3/T4 / uneven number of channel plates at
connections T1/T2.

T1 T2 T3 T4 locations on back side
correspond to S1 S2 S3 S4 on front side

ALL DIMENSIONS IN MILLIMETERS

SIDE	MEDIA	INLET	TEMP.	OUTLET	TEMP.	FLOW RATE	PRESSURE DROP	LIQUID VOL.
1								0.31 dm ³
2								0.34 dm ³

PRESSURE VESSEL APPROVAL

PED

CB20-24H (3287000014)

www.alfalaval.com

CUSTOMER NAME / REF. NO.

TOTAL LENGTH 66.8 mm
TOTAL WIDTH 94.0 mm
TOTAL HEIGHT 324.0 mm

COMPANY / REF.

6/22/2017
REV 0