

FRAME PLATE

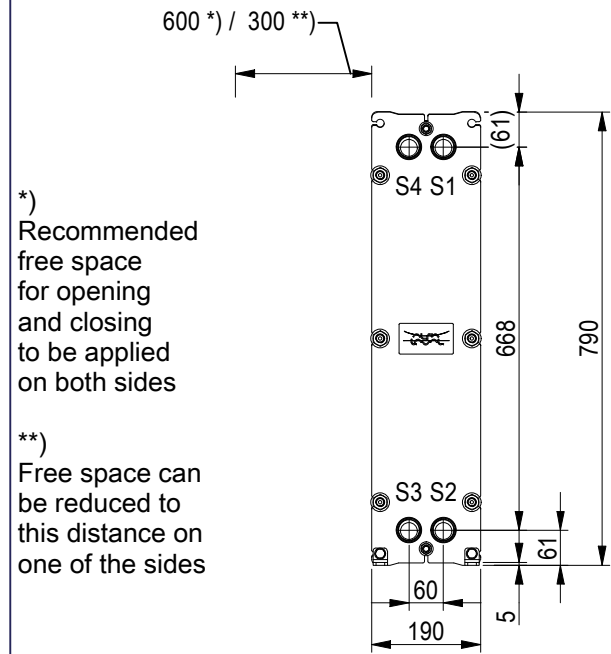

*) Recommended free space for opening and closing to be applied on both sides

**) Free space can be reduced to this distance on one of the sides

Space between pressure plate and supporting column should be kept free from fixed installations!

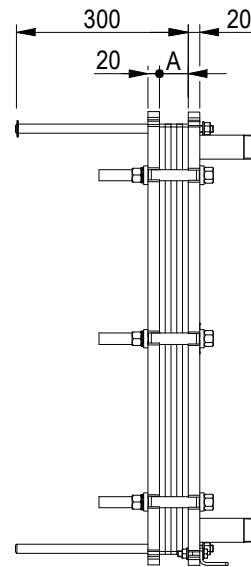

PRESSURE PLATE (MOVABLE)

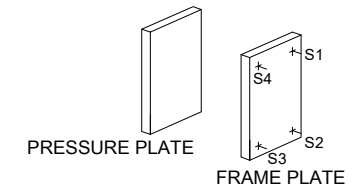
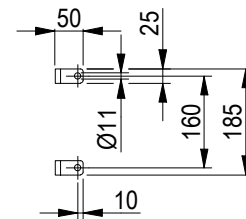
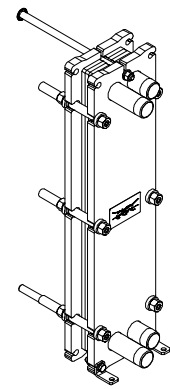
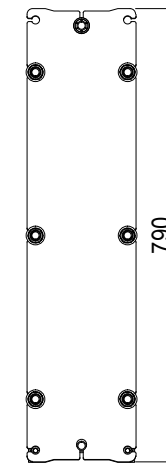

ISO 7 - R 1 1/4, ALLOY 316, 80 mm
S1, S2

A-A:

ISO 7 - R 1 1/4, ALLOY 316, 120 mm
S3, S4

C-C:

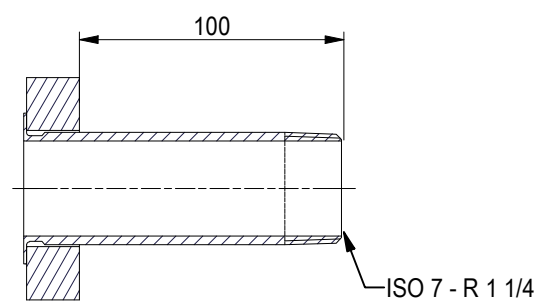
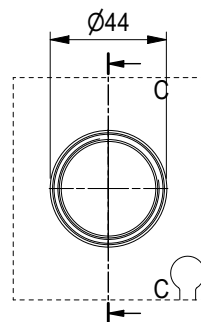
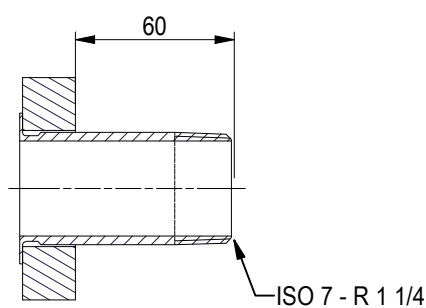
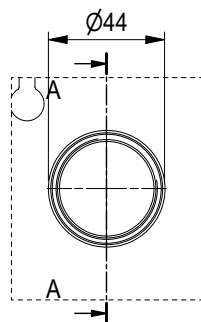

All dimensions in millimeters (mm)

NO. OF UNITS

1

APPROX. OUTER DIMENSIONS

LENGTH 310 mm
WIDTH 200 mm
HEIGHT 800 mm

APPROX. WEIGHTS

NET WEIGHT, EMPTY 47.1 kg
WEIGHT FULL OF WATER 49.3 kg

PLATE MATERIAL ALLOY 316
PLATE THICKNESS 0.5 mm
GASKET NBRP Clip-on

CHANNEL ARRANGEMENT 1*4 ML / 1*5 MH



www.alfalaval.com

DRAWING
GASKETED PLATE HEAT EXCHANGER

TL3-PFG

PED Article 4.3

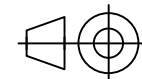

8240123769

Do not use this drawing for foundation bolting or piping layout

DATE 2/26/22
REVISION 0