

FRAME PLATE

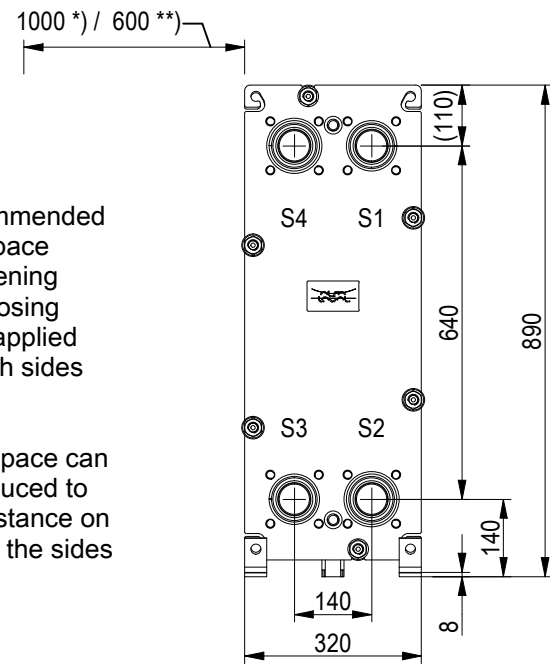

*) Recommended free space for opening and closing to be applied on both sides

**) Free space can be reduced to this distance on one of the sides

Space between pressure plate and supporting column should be kept free from fixed installations!

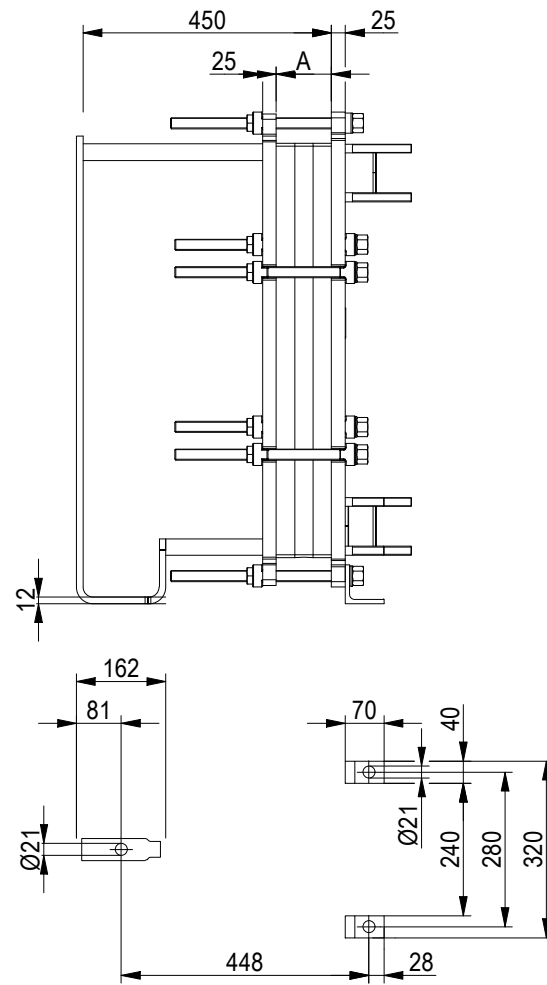

PRESSURE PLATE (MOVABLE)

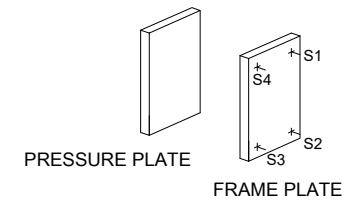
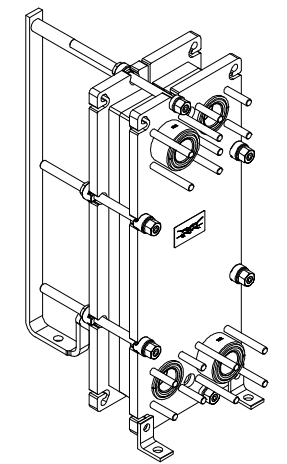
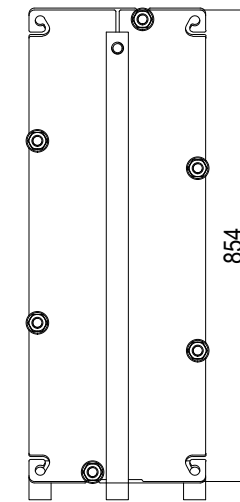

EN 1092-1 DN50 PN16
S1, S3

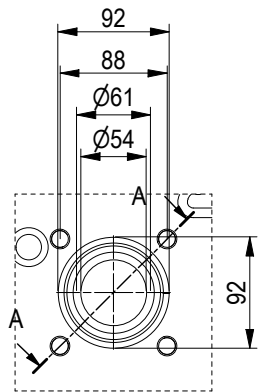

A-A:
NBRP / ALLOY 316

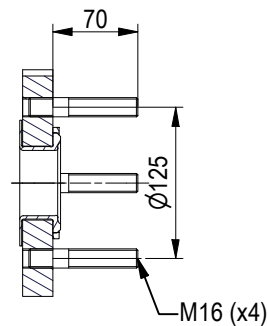

EN 1092-1 DN50 PN16
S2, S4

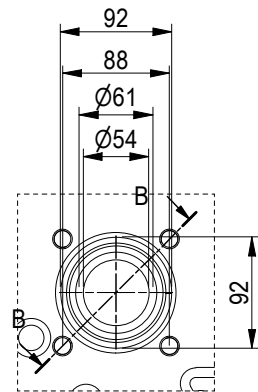

B-B:
NBRP / ALLOY 316

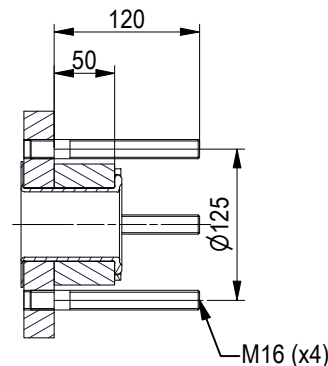

All dimensions in millimeters (mm)

NO. OF UNITS

1

APPROX. OUTER DIMENSIONS

LENGTH	640 mm
WIDTH	330 mm
HEIGHT	880 mm

APPROX. WEIGHTS

NET WEIGHT, EMPTY	171 kg
WEIGHT FULL OF WATER	189 kg
PLATE MATERIAL	ALLOY 316
PLATE THICKNESS	0.5 mm
GASKET	NBRP ClipGrip™

CHANNEL ARRANGEMENT 1*34 ML
/ 1*35 MH



www.alfalaval.com

DRAWING
GASKETED PLATE HEAT EXCHANGER

T6-BFG

PED Article 4.3

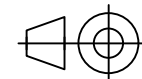

8240120746

Do not use this drawing for foundation bolting or piping layout

DATE 2/21/22
REVISION 0