

FRAME PLATE

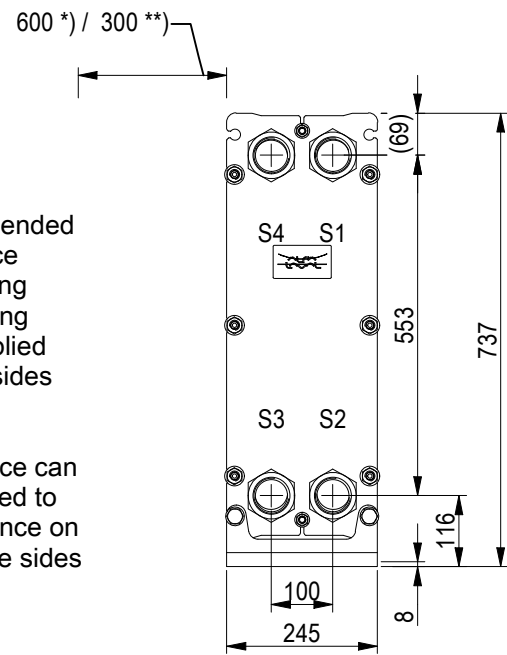

*) Recommended free space for opening and closing to be applied on both sides

**) Free space can be reduced to this distance on one of the sides

Space between pressure plate and supporting column should be kept free from fixed installations!

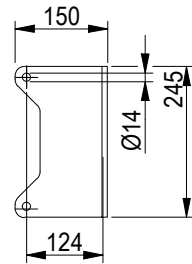
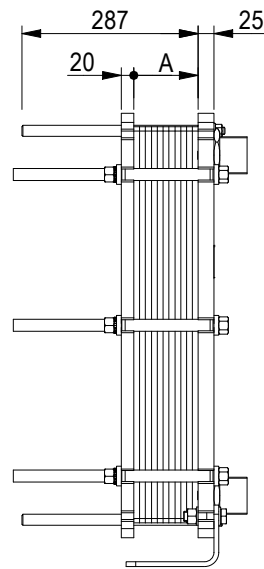

PRESSURE PLATE

(MOVABLE)

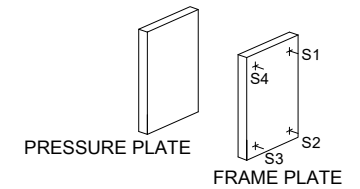
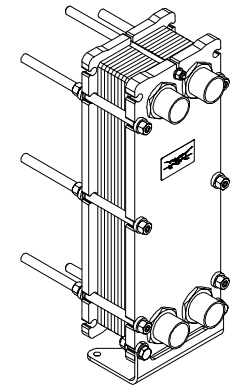
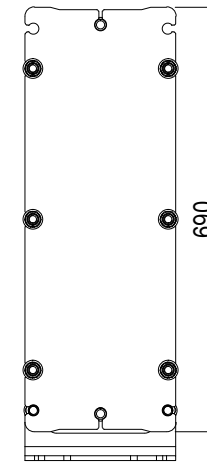

ISO 228 - G 2 B, ALLOY 316, 80 mm
S1, S2, S3, S4

A-A:

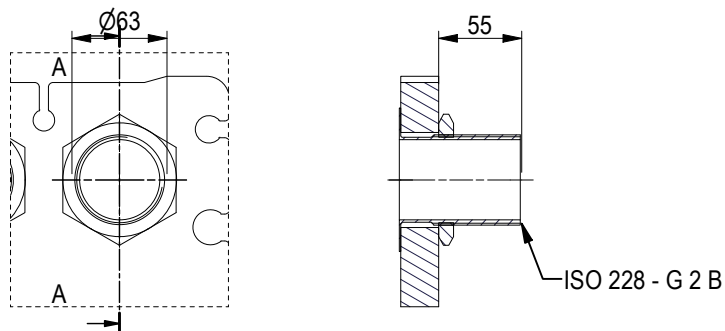

All dimensions in millimeters (mm)

NO. OF UNITS

1

APPROX. OUTER DIMENSIONS	
LENGTH	300 mm
WIDTH	260 mm
HEIGHT	700 mm
APPROX. WEIGHTS	
NET WEIGHT, EMPTY	84.2 kg
WEIGHT FULL OF WATER	90.8 kg
PLATE MATERIAL	ALLOY 316
PLATE THICKNESS	0.5 mm
GASKET	NBRP Clip-on

CHANNEL ARRANGEMENT 1*22 ML
/ 1*22 MH



www.alfalaval.com

DRAWING
GASKETED PLATE HEAT EXCHANGER

T5-BFG

PED Article 4.3

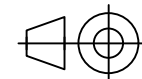

8240124149

Do not use this drawing for foundation bolting or piping layout

DATE 2/28/22
REVISION 0