

FRAME PLATE

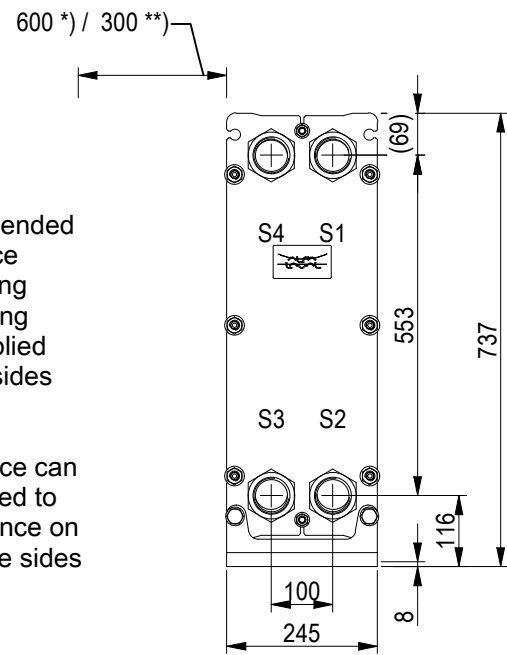

*) Recommended free space for opening and closing to be applied on both sides

**) Free space can be reduced to this distance on one of the sides

Space between pressure plate and supporting column should be kept free from fixed installations!

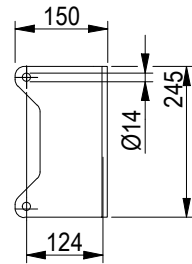
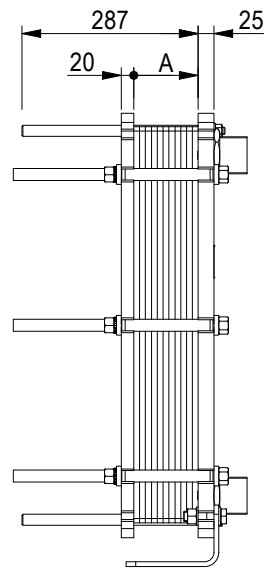

PRESSURE PLATE (MOVABLE)

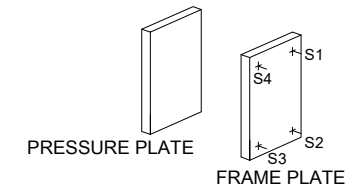
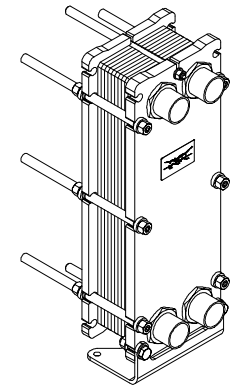
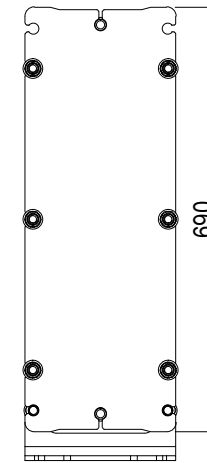

ISO 228 - G 2 B, ALLOY 316, 80 mm
S1, S2, S3, S4

A-A:

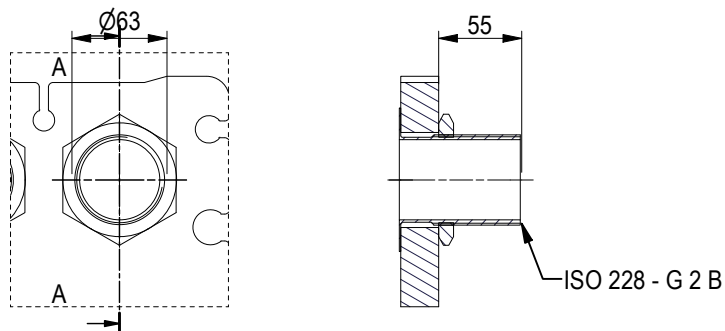

All dimensions in millimeters (mm)

NO. OF UNITS

1

APPROX. OUTER DIMENSIONS

LENGTH 300 mm
WIDTH 260 mm
HEIGHT 700 mm

APPROX. WEIGHTS

NET WEIGHT, EMPTY 76.1 kg
WEIGHT FULL OF WATER 80.6 kg
PLATE MATERIAL ALLOY 316
PLATE THICKNESS 0.5 mm
GASKET NBRP Clip-on

CHANNEL ARRANGEMENT 1*14 H
/ 1*15 H



www.alfalaval.com

DRAWING
GASKETED PLATE HEAT EXCHANGER

T5-BFG

PED Article 4.3

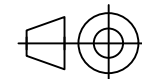

8240124318

Do not use this drawing for foundation bolting or piping layout

DATE 2/28/22
REVISION 0