

Installation, service and operating instruction Cetetherm Mini Plus CM737

District heating substation for single-family houses and multi-family buildings (1 to 12 apartments)

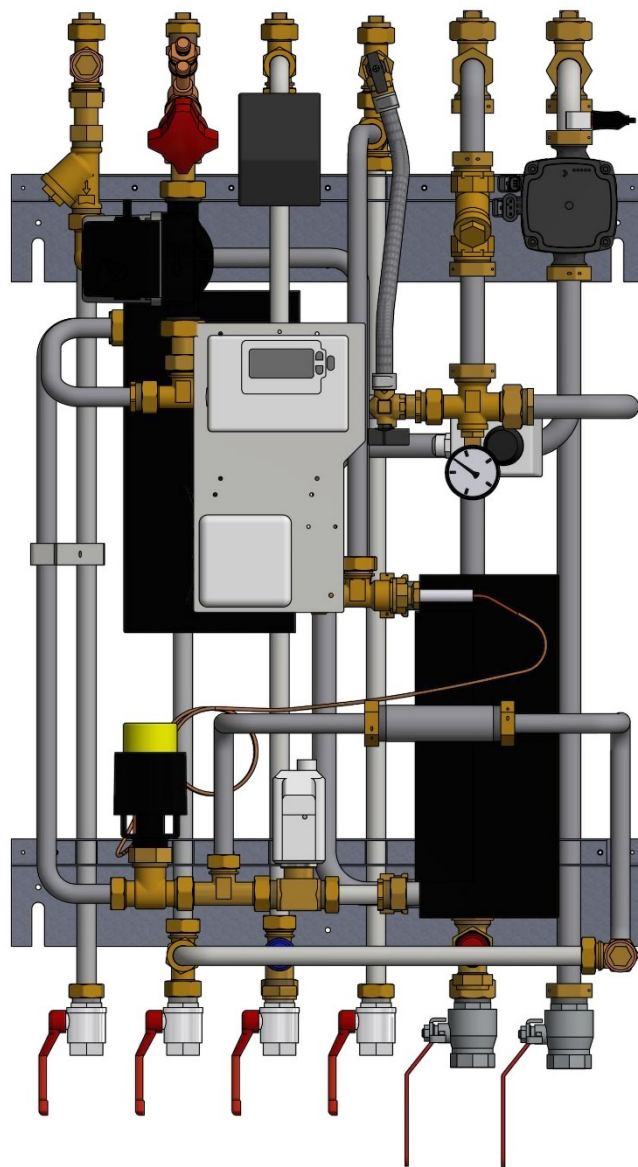

For additional online information and manual:

URL address:

<https://www.cetetherm.com/miniplus>

QR-code:



Cetetherm District heating substation			
Cetetherm Mini Plus...			
Main No. xxxxxx			
Part No. xxxxxx			
Main Year 2018			
	Primary	Heating	DHW
Design pressure	PSI	015	010
Design temp	TS °C	0120	090
Leakage test	bar	2	2
Volume	V L	1.01/1.57	1.05
Safety valve release press	bar	2.5	9
Capacity	kW	40	58
Temp range	°C	100-63/90-80 55-22/13-55	
Electrical conn.	230V, 1-		
Fluid group 2, PED 2014/68/EU art 4.3			
Manufacturer Cetetherm AB, Rönneby, Sweden			

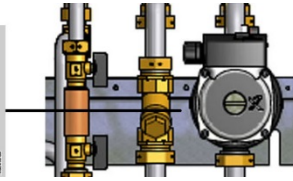

This manual is published by Cetetherm.

Cetetherm can without further notice make changes and improvements to the content in this manual if it is necessary due to printing mistakes, wrong information or changes in the hardware or software.

All these types of changes will be included in future release of the manual.

Contents

1	General information.....	3
1.1	Comfort.....	3
1.2	Installation.....	3
1.3	Long-term security.....	3
1.4	CE-marking.....	3
1.5	Information about the document.....	3
1.6	General warnings.....	4
2	Operating instructions.....	5
2.1	Operation.....	5
2.2	Safety equipment/inspection.....	5
3	Product overview.....	6
4	Installation.....	7
4.1	Unpacking.....	7
4.2	Preparation.....	7
4.3	Mounting.....	7
4.4	Mounting options.....	8
4.5	Adjustments and settings.....	8
4.6	Dismantlement.....	8
4.7	Commissioning advice.....	8
5	Measure sketch Mini Plus.....	9
6	Control panel with room thermostat CM737.....	10
6.1	General.....	10
7	Installing and start up the control panel.....	11
7.1	Using the control panel as a room thermostat.....	11
7.2	Installing the outdoor temperature sensor.....	13
7.3	Starting up and component control of control panel.....	13
7.4	Configure the control panel after installation.....	13
7.5	Setting the day.....	14
7.6	Setting the time.....	14
8	Operating the room thermostat CM737.....	15
8.1	Choosing the operating mode.....	15
8.2	Temperature Enquiry with the Info-button (7).....	15
8.3	Holiday function.....	16
8.4	OTC heating curve.....	16
8.5	Parallel adjustment of heating curve.....	16
8.6	Operating mode Auto.....	17
8.6.1	The Built-in Heating Program.....	17
8.6.2	Reviewing the Heating Program.....	17
8.6.3	Temperature Override.....	17
8.6.4	Disabling/enabling time periods.....	17
8.6.5	Modifying the heating program.....	18
9	Activation of installer parameters.....	19
9.1	Entering the installer set-up mode.....	19
9.2	Category 1 parameters: Control panel settings.....	20
9.3	Category 2 parameters: ECO-functions.....	20
9.4	Category 3 parameters: Setting and displaying sensor values.....	21
9.5	Category 4 parameters: Heating actuator settings.....	21
9.6	Category 5: Fault History.....	21
10	Troubleshooting the control panel.....	22
10.1	Fault codes on the control panel.....	23
11	Electrical circuit diagram.....	24
12	Schematic diagram, main components.....	25
13	Pump settings and pump performance.....	26

Cetetherm Mini Plus CM737

Installation, service and operating instruction

13.1	General.....	26
13.2	DHWC-pump Grundfos UPSO 15-55.....	26
13.3	Heating circuit pump Grundfos UPM3 Auto L 50-70 130.....	27
13.3.1	Pump curve proportional pressure mode 2, PP2.....	28
13.3.2	Change pump operating mode.....	28
13.3.3	Key lock function.....	28
13.4	Heating circuit pump Grundfos UPML 25-105 180 Auto, settings and capacity.....	29
13.4.1	Changing pump curve setting.....	30
14	Fault finding pump.....	31
14.1	Fault finding UMP3 pump.....	31
15	Service instructions.....	32
15.1	Tap water service instructions.....	32
15.1.1	Tap water temperature too low.....	32
15.1.2	Tap water temperature too high.....	32
15.1.3	Hot water temperature unstable.....	32
15.1.4	Noise in the DHWC system.....	33
15.2	Heating system service instructions.....	33
15.2.1	Heating system temperature too high or too low.....	33
15.2.2	No heating.....	34
15.2.3	Heating system often needs topping up.....	35
15.2.4	Heating temperature unstable.....	35
15.2.5	Noise in the radiator system.....	36
16	Service actions for the installer.....	37
16.1	Check the function of the valve for hot water.....	37
16.2	Check the heating actuator and valve function.....	38
16.3	Check the circulation pump Grundfos UPS.....	38
16.4	Run the pump manually.....	39
16.5	Check the volume take-up and pressure equalizing of the expansion vessel.....	39
17	Maintenance and repairs.....	40
17.1	Cleaning the district heating filter.....	40
17.2	Cleaning the heating circuit filter.....	40
17.3	Change the complete DHWC pump or pump components.....	41
17.4	Change the complete heating pump or pump components.....	42
17.5	Change the heating supply temperature sensor.....	42
17.6	Change the outdoor temperature sensor.....	43
17.7	Change the heating actuator.....	43
17.8	Change the heating valve.....	44
17.9	Change the hot water valve.....	44
17.10	Change the hotwater actuator and sensor.....	45
17.11	Change the DHWC check valve.....	46
17.12	Change the expansion vessel.....	46
18	Options.....	47
18.1	Safety thermostat.....	47
18.1.1	Parameters and recommended settings for under floor heating.....	47
19	Operating data and performance.....	48
19.1	Operating data Mini Plus CB30-60H.....	48
19.2	Operating data Mini Plus CB18-54H.....	48

1 General information

Cetetherm Mini Plus is a complete, ready-to-install heating network substation for heating and hot water. It is designed for buildings with a primary connection to a heating network. Cetetherm has years of experience in heating network technology and has developed Mini Plus with well-planned pipe work and with all components easily accessible for inspection and possible future servicing.

1.1 Comfort

Mini Plus has fully-automatic temperature control for heating and hot water. The heating is controlled in relation to outdoor temperature and/or desired room temperature. The hot water is controlled and maintained at the desired temperature.

1.2 Installation

Well planned pipe work and readymade electrical wiring make installation very simple. A pre-programmed controller and plug-and-socket connection provide further simplification, so that the substation can be started without delay. The Mini Plus is designed for hanging on the wall.

Mini Plus is supplied fully wired. The wiring conforms to the applicable rules for CE marking and has undergone electrical safety testing and function testing. For permanent installation, the substations must be connected via an all-pole isolator switch.

The substation must be connected to a grounded wall socket.

1.3 Long-term security

All the plates and pipes in the heat exchanger are made of acid-resistant stainless steel for long life. All components are adjusted together and undergo thorough function testing in accordance with Alfa Laval's ISO 9001:2008 quality assurance system. For future servicing requirements, all components are easily accessible and individually replaceable.

1.4 CE-marking









Mini Plus is CE-marked to certify that the substation conforms to international safety regulations. To maintain the validity of the CE marking, only identical replacement parts must be used.

1.5 Information about the document

All pictures in this document are general images.

Mini Plus is available in different models and levels of equipment.

1.6 General warnings

	The installation work must be carried out by an authorized installation contractor. Before the system is taken into operation, it must be pressure tested in accordance with relevant regulations.
	The temperature and the pressure of the district heating water are very high. Only qualified technicians can work with the district heating substation. Incorrect operation may cause serious personal injury and result in damage to the building.
	If the hot water temperature is set too high, people may be scalded. If the hot water temperature is set too low, unwanted bacteriological growth may occur in the hot water system. This can result in serious personal injury.
	Parts of the substation may get very hot and should not be touched.
	Before the substation is connected to the electrical supply, make sure that the secondary heating system is topped up with water. Starting up the system without water will damage the circulation pump.
	The substation comes prepared with an electrical plug to be connected to the main supply. The strain relief clips of the cable must be fitted so that there is no risk of damage. If necessary, the plug-and-socket connection can be replaced with a permanent installation with an all-pole isolate switch. This must be carried out by a qualified electrician.
	When starting up the district heating substation, to avoid the risk of scalding, make sure that no-one draws any hot water until the hot water temperature has been adjusted.
	Start district heating circulation by first opening the valve in the district heating supply and then return lines, to avoid pollutions in the system. Open the valves slowly to avoid pressure surges. Do the same way with the heating circuit, first open the valve for heating return then supply .
	Do not shut of the electrical supply to the operator control panel. This will damage the circulation pump, valves, actuators etc.

2 Operating instructions

2.1 Operation

The temperature and pressure of the incoming heating network water from the culvert network are very high. For this reason, only the heat from this water is used. The heating network water does not enter the heating and hot water systems of the building.

The heat from the heating network water is transferred to the heating and hot water systems of the building in the heat exchangers. The heat is transferred through thin plates of acid-resistant stainless steel which keep the heating network water separate from the systems in the building.

Mini Plus has automatic temperature control for heating and hot water. The heating circuit is controlled in relation to outdoor temperature and/or desired room temperature by means of a controller and temperature sensor. When no heat is needed, the circulation pump in the heating circuit stops automatically, but is started regularly to make sure that it does not seize up during long idle periods. The hot water temperature is controlled by a temperature control system which is set to about 55 °C.

After adjustment, the Mini Plus operates completely automatically. However, in hard water areas it is advisable to be attentive and to remedy any faults in good time if the temperature of the hot water is too high, otherwise the risk of lime deposits in the heat exchanger may increase.

2.2 Safety equipment/inspection

- Daily inspection to check for leaks from pipes or components.
- Weekly inspection to make sure that the operation of the heating and hot water control systems is stable and that the temperature does not fluctuate. Temperature variation causes unnecessary wear of valves, actuators and heat exchangers.
- Every three months check the safety valves and the pressure in the heating system.

To check the operation of a safety valve, turn its wheel/knob until water escapes from the valve, then close the wheel/knob quickly. Occasionally a safety valve may open automatically to release excess pressure. After a safety valve has been open it is important that it closes properly and does not drip.

The heating system is topped up via the heating filler valves, see [15.2 Heating system service instructions](#). Be sure to close the valves when the correct pressure is reached. The water used to top up the system contains oxygen and may cause corrosion in the system. For this reason, the system should be topped up as seldom as possible, at most once a year, when the heating system has been thoroughly bled and balanced.

Hot water temperature in apartments or one family houses can be set to about 55°C. If the temperature is set too high, there is a risk of scalding. Setting the hot water temperature too low may result in unwanted bacteriological growth in the hot water system.

For setting and (if necessary) fine adjustment of the heating and hot water temperatures, see [chapter 8](#).

3 Product overview

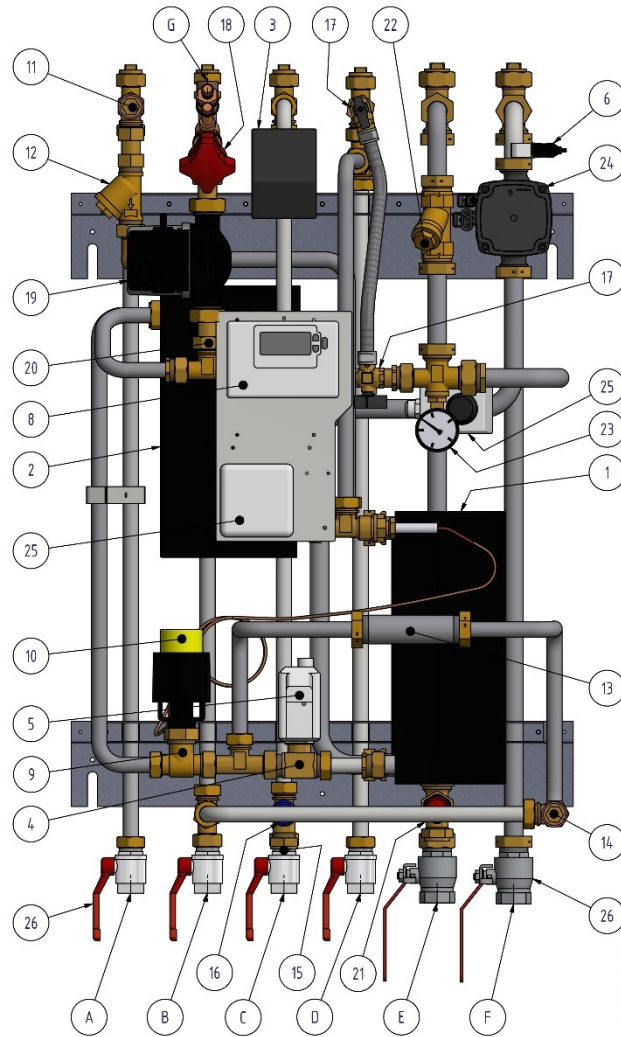

Picture 1

1	Heat exchanger for heating	18	Balancing valve DHWC
2	Heat exchanger for domestic hot water	19	Circulation pump DHWC
3	Connection box for electric power and sensors	20	Check valve for DHWC
4	Control valve, heating circuit	21	Safety valve for heating circuit
5	Actuator, heating circuit	22	Filter for heating circuit
6	Supply temperature sensor, heating circuit	23	Pressure gauge for heating circuit
7	Outdoor temperature sensor (not in picture)	24	Circulation pump heating
8	Operator control panel with room thermostat	25	Safety thermostat (option)
9	Control valve for domestic hot water	26	Shutoff valves
10	Actuator and sensor for domestic hot water	A.	District Heating Supply
11	Temperature sensor connection, DH supply	B.	District Heating Return
12	Filter for district heating supply	C.	CW
13	Adapter for energy meter	D.	DHW
14	Temperature sensor connection, DH return	E.	Heat, Return
15	Check valve for cold water	F.	Heat, Supply
16	Safety valve for domestic hot water	G.	DHWC
17	Valve to top up the heating circuit		

4 Installation

4.1 Unpacking

- Remove the transport packaging and check that the product has not been damaged in transit and that the consignment agrees with the specifications.
- When lifting the unit, take care not to apply stress to pipes and heat exchangers as this may weaken them. Avoid lifting the unit by holding the heat exchangers.

Note: Risk of injury lifting heavy objects.

4.2 Preparation

- Choose a suitable installation area in accordance with official regulations. The system may generate sounds during operation caused by pumps, regulators systems, flows etc. This should be taken into consideration during installation of the unit, so that possible operational sounds affect the surroundings as little as possible. This means that the system should be installed on well-insulated walls, such as outer walls or on concrete walls.
- Check the applicable regulations of the district heating supplier. The available differential pressure should be at least 100 kPa and at most 600 kPa. Where the differential pressure is higher, a differential pressure controller should be added to the installation.
- Flush out the heating and hot water systems.

4.3 Mounting

- Mount the substation on the wall using four screws or bolts suitable for the material of the wall and for the weight of the unit. The unit may be mounted at any height on the wall, 1500 – 1800 mm from floor to keyhole fixing may be taken as a guide. The hole pattern for screws/bolts and the piping connection measures is shown in [5 Measure sketch Mini Plus](#).
- Install enclosed check valve for cold water in cold water pipe.

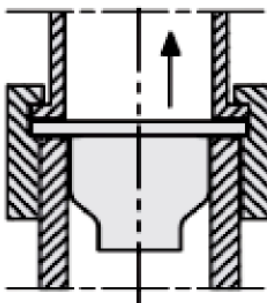

Picture 2; Installation of check valve in cold water pipe.

- Connect the pipe work to the connection points. Use the enclosed shutoff valves with flat contact face.
- Drainage pipes from safety valves must be taken to floor gully.
- Energy meters must be installed at a prepared location, replacing a gauge block, or following the instructions of the energy supplier.
- Retighten all connections, including those made at the factory. If connections need retightening after the installation has been taken into service, the system should be depressurised before retightening. If the system is not depressurised before retightening, gaskets will be damaged.
- Mount the outdoor temperature sensor on the north side of the building, 2 metres above the ground, or higher. For installation of the outdoor temperature sensor, see [7.2 Installing the outdoor temperature sensor](#).
- For installation of the operator control panel see [7.1 Using the control panel as a room thermostat](#).

4.4 Mounting options

- If the substation is connected to a system sensitive to high temperature or to a low temperature system, for example floor heating, a safety thermostat must be mounted and activated before start up. See chapter [18.1 Safety thermostat](#).

4.5 Adjustments and settings

- Open incoming cold-water supply and fill the service water and heating circuits, bleeding off any trapped air.
- Allow 5 minutes for the controller start up sequence and to regain functionality after a power cut. See [7.3 Starting up and component control of control panel](#).
- Check the operation and opening pressures of the safety valves.
- Now adjust the hot water temperature by having a hot water tap open at normal flow rate for a time. Measure the temperature at the draw-off point with a thermometer. The temperature should be approximately 55°C. It takes about 20 seconds to get stable tap water temperature. See [15.1 Tap water service instructions](#) for adjusting hot water temperature.

NOTE: Make sure that no cold water is mixed with the hot water while making this adjustment.

- Start the heating circulation pump with the highest output setting. Let the heating system heat up and bleed the system again, see [15.2 Heating system service instructions](#). After final bleeding, the pressure should not be less than 1.0 bar in winter and not less than 0.6 bar in summer.
- Set the pump capacity of the heating circulation pump according to the pressure head diagram. Use the lowest setting that manages the heating demand for best electrical efficiency.
- Activate the outdoor sensor (needed for heating curve control) and/or room temperature sensor via the room panel. See [7.4 Configure the control panel after installation](#).
- Set the day and time on the operator control panel. See [7.5 Setting the day](#) and [7.6 Setting the time](#).
- Set the operating mode on control panel. See [8.1 Choosing the operating mode](#).
- The property owner must be instructed in the operation, setting and care of the unit. It is particularly important to provide information about the safety systems and about hazards that may arise in relation to the high pressure and temperature of the district heating water.

4.6 Dismantlement

When the time comes for the substation to be dismantled and scrapped it must be disposed of in the correct manner in accordance with local or national regulations.

4.7 Commissioning advice

The controller has been set at the factory. If any function needs tuning, values can be changed regarding this manual for parameter setting. Initially, the commissioning process should be carried out with the factory settings. To activate Eco function or summer heating, see [9.3 Category 2 parameters: ECO-functions](#).

5 Measure sketch Mini Plus

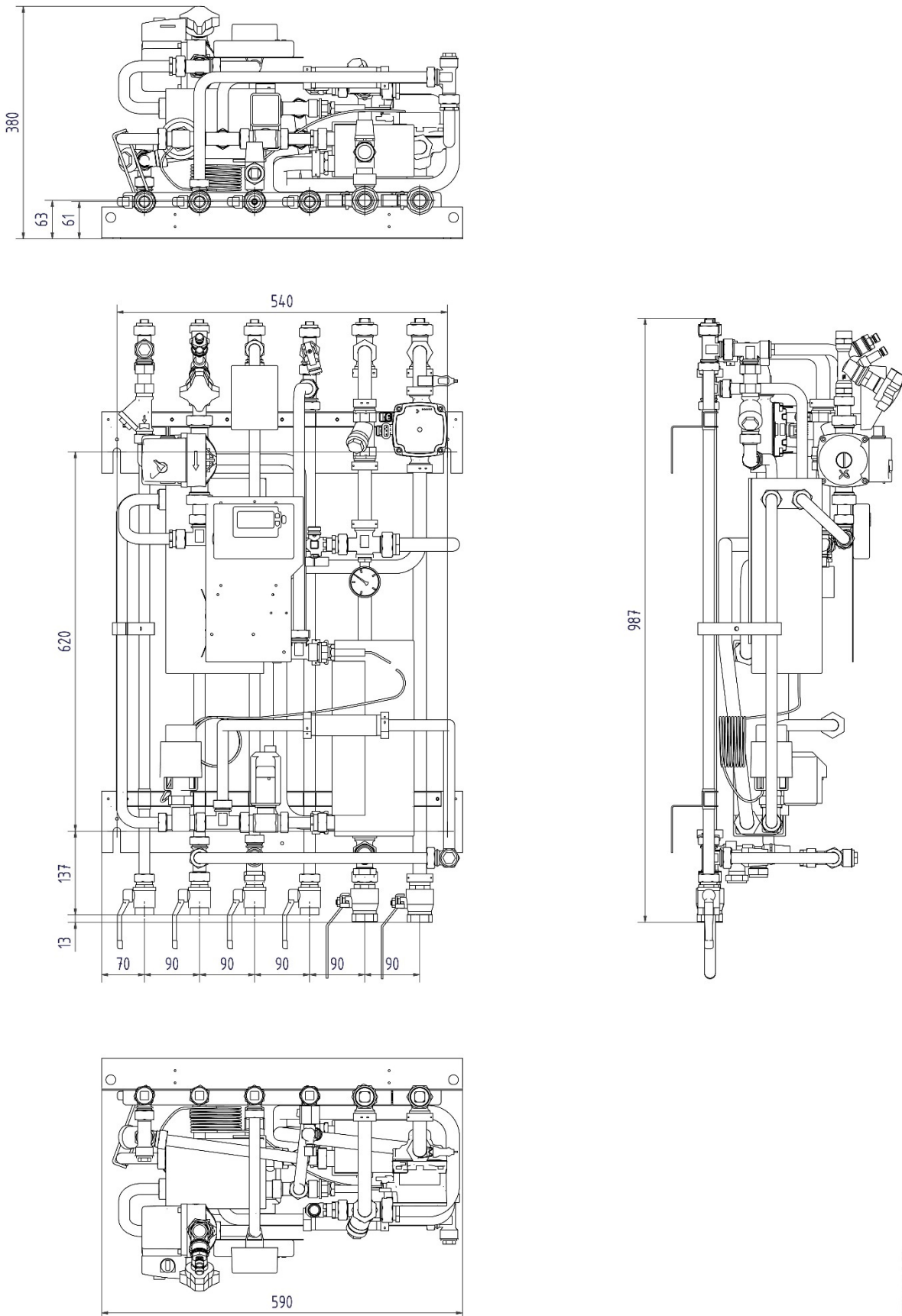

Picture 3

6 Control panel with room thermostat CM737

6.1 General

The room thermostat CM737 controls the supply temperature to the heating system. When connecting unit to the power supply, the room thermostat verifies the connected sensors and then automatically chooses to control by room or outdoor temperature sensor or both.

Features:

- Ergonomic user interface.
- Large LCD (Liquid Crystal Display) Screen.
- Four independent temperature levels per day, from 5°C to 35°C.
- Built-in Memory holds the user program indefinitely.
- Holiday button saves energy by letting you reduce the temperature for 1 to 99 days.
- 7- days heating program to match your lifestyle, and maximizing energy savings.

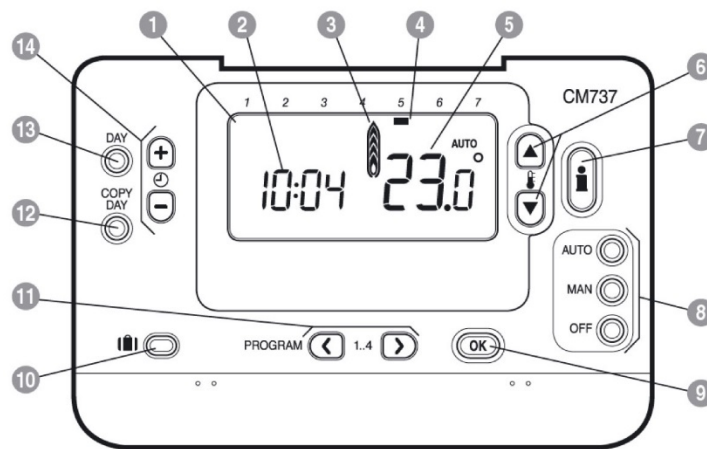

Picture 4

1	LCD display	6	Temperature change buttons	11	Program buttons
2	Time display	7	Temperature enquiry button	12	Copy day button
3	Heating indicator	8	Operating mode buttons	13	Day select button
4	Day indicator	9	OK button, green	14	Time change buttons
5	Temperature display	10	Holiday function button		

OK-button (9)

When changing settings/values in room thermostat, the numbers in the display is flashing. Confirm the new settings with the green OK-button (9) and the new setting will be confirmed.

7 Installing and start up the control panel

7.1 Using the control panel as a room thermostat

The control panel can be used as a room thermostat.

Before installation make sure that the electrical power supply is disconnected.

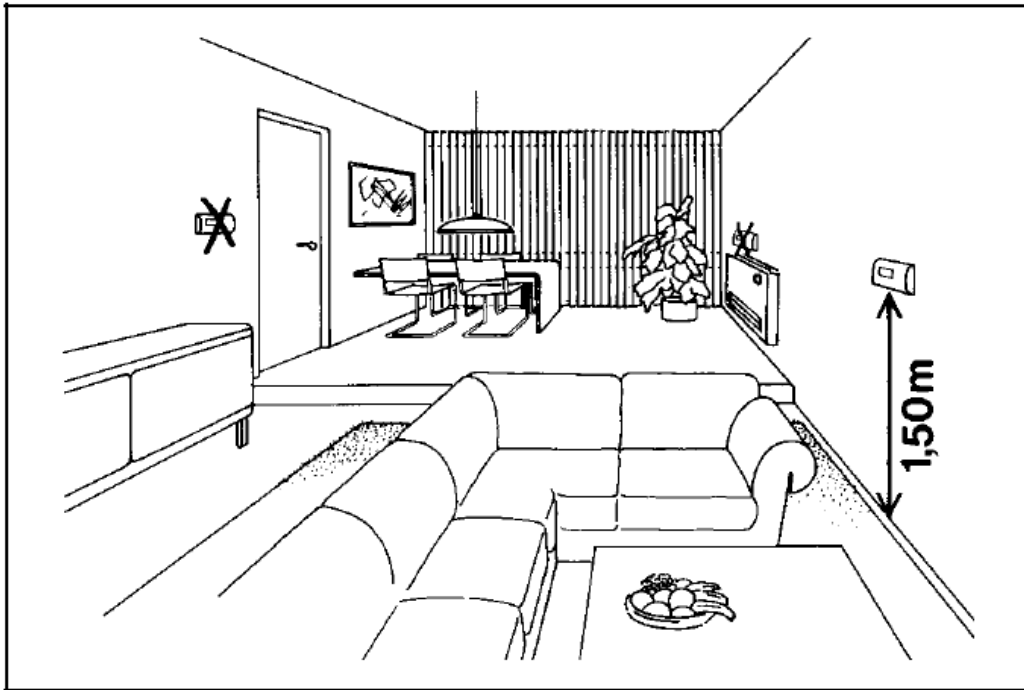

Picture 5

Install the room thermostat in the living space according to following:

- A suitable installation is about 1.5 meters above floor and on an inner wall.
- The room thermostat must not be combined with other thermostats in the same control zone.

Use a suitable 2-conductor cable between the connection box and the operator control panel. With a conductor area of 0.6 mm², the maximum cable length is 50 metres. Maximum 5Ω/conductor. Install the cable ends in the terminal, marked A and B, located in the operator control panel. Connect the plug to the connection box again. The unit can now be connected to the electrical power.

After starting up, choose configuration and operating mode, see [7.4 Configure the control panel after installation](#).

Cetetherm Mini Plus CM737

Installation, service and operating instruction

1



SW Innan installationen av CM737, koppla bort matningsspänningen till reglercentralen.

ENG Before installing the CM737 disconnect the power supply to the heating appliance!

F Avant d'installer, l'alimentation du l'appareil de chauffage doit être coupé!

2

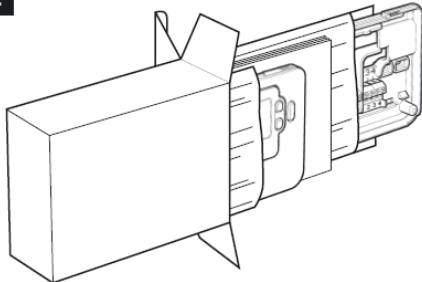

3

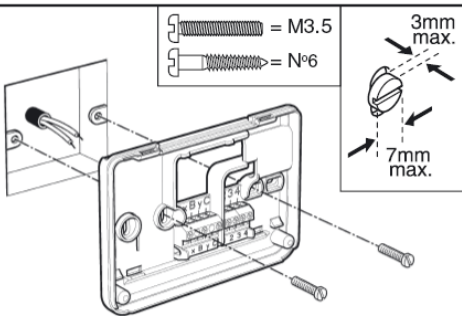

4

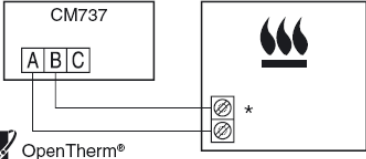

SW * Refererar till installationsanvisningen för reglercentralen.

ENG Refer to the installation manual for the heating appliance.

F Pour la numérotation exacte des bornes, référez vous aux instructions fournies avec votre chaudière.

5

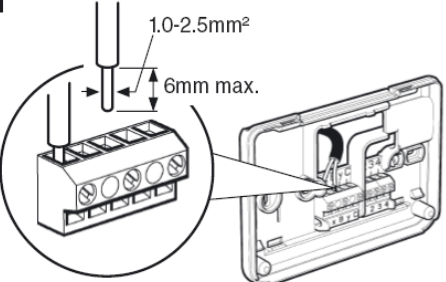

6

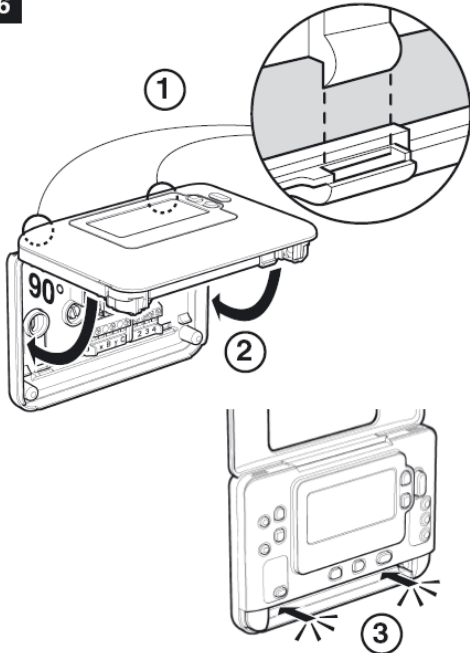

7

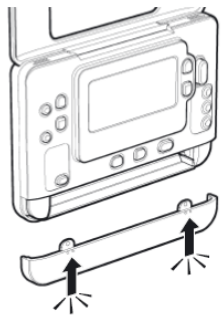

8

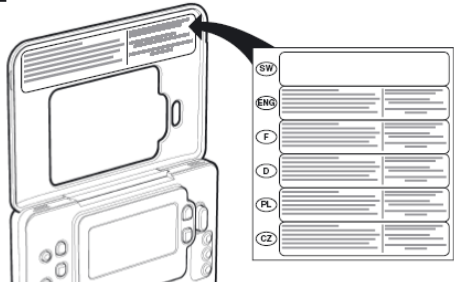

9

SW Koppla bort matningsspänningen till reglercentralen.

ENG Reconnect the power supply to the heating appliance.

F Rétablir l'alimentation sur l'appareil de chauffage.

Picture 6

7.2 Installing the outdoor temperature sensor

Connect the outdoor temperature sensor to the terminal strip in accordance with the electrical diagram, remove any resistor.

With a conductor area of 0.6 mm² the maximum cable length is 50 metres and maximum 5Ω/conductor. When the outdoor temperature sensor cable is connected to a terminal strip, the connecting cable must be long enough for the controller and its mounting plate to be lifted off.

If the outdoor temperature sensor is connected later, for example in a construction period, the current must be disconnected for a few minutes.

Set parameter 14 according to requested compensation; see [7.4 Configure the control panel after installation](#).

The installation must be connected to a grounded wall socket.

7.3 Starting up and component control of control panel

Note: The substation must be filled with water before starting the room thermostat, if not the pump can be damaged.

1. Put the electrical cable from the control panel into a wall outlet.
2. Check the heating actuator (knob turns) on and pump function. In start-up mode, the components manoeuvre by the following schedule:
 - 10s actuator clockwise, if not closed at start
 - 10s actuator counter clockwise
 - 10s actuator clockwise
 - 10s pump runs
 - 150s actuator closes

After approximately another 4 minutes the room thermostat changes from start up to normal regulation.

3. Press the **MAN** (8) button for a fixed set point (no reduction) of the room temperature.
4. Adjust the room temperature with the increase/decrease buttons on the right (6).

By outdoor compensation this change represents a standard parallel shift of the heat curve, recalculated for room temperature. For more details see chapter [8.5 Parallel adjustment of heating curve](#).

7.4 Configure the control panel after installation

The room thermostat can be configured in three different ways. All installation parameters can be found in the parameter list, see [9 Activation of installer parameters](#).

The control panel is pre-set to Outdoor compensation.

- Outdoor compensation, require a connected outdoor temperature sensor, see [7.2 Installing the outdoor temperature sensor](#). Set parameter 14:rC to 1.
- Room compensation, require a mounted room thermostat, see [7.1 Using the control panel as a room thermostat](#). Set parameter 14:rC to 0.
- Outdoor and room compensation, require a connected outdoor temperature sensor and a mounted room thermostat see [7.2 Installing the outdoor temperature sensor](#) and [7.1 Using the control panel as a room thermostat](#). Set parameter 14:rC to 2.

7.5 Setting the day

1. Press the DAY button to begin setting the day, (1-7=mon-sun).
Each press will move the day indicator one step forward.
After 7 it will start over again at 1.
Press the green **OK** button to confirm.

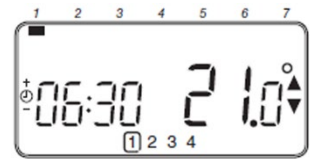

7.6 Setting the time

1. Press either of the or buttons once to enter timer setting mode. The LCD screen flashes the time digits. When the unit is powered for the first time the display shows 12:00.
2. Use the or buttons to set the correct time then press the green **OK** button to confirm.
Each press of the buttons will change the time by one minute and holding them down will change the time slowly at first and get progressively quicker.



NOTE: to leave this mode, press the **AUTO**, **MAN** or **OFF** buttons.



8 Operating the room thermostat CM737

8.1 Choosing the operating mode

The room thermostat can operate in three different modes; Automatic, Manual or Off.

To set the operating mode press either of the **AUTO**, **MAN** or **OFF** buttons. The screen indicates which mode is currently active.

NOTE: Cetetherm recommends the mode **MAN**.

- **MAN (manual)** the room thermostat acts with a fixed set point throughout the day.
The set point can be adjusted from 5°C to 35°C by using the  or  buttons.
The thermostat will continue to maintain this temperature until another operating mode or temperature is selected.
- **AUTO (automatic)** the room thermostat follows the built-in temperature program, default or modified.
A manually adjustment of the temperature with arrow “up” or “down” is only valid until next programmed temperature change.
NOTE: The built-in heating program has been designed to provide normal comfort requirements, but to customise the settings please see [8.6 Operating mode Auto](#).
- **OFF** the room thermostat controls to a minimum temperature. Default setting of 5°C acts as a frost protection for your home.

8.2 Temperature Enquiry with the Info-button (7)

Each value will be displayed for 3 second before returning to show the initial screen.

NOTE! The initial screen shows different temperatures depending on if the outdoor temperature sensor is connected and the setting of parameter 14:rC in the room thermostat.

- Target room temperature - with outdoor compensation.
- Current room temperature – with room compensation.

Press ones on the info-button , the display will show one of following three:

1. **EXT above the clock and a temperature.**

The outdoor temperature sensor is installed correct and the controls the heating.
Displayed temperature is present outside temperature, according to the sensor.

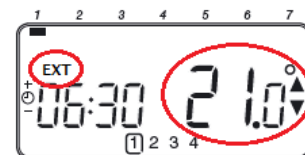

Press ones more on the **Info**-button, in 3 seconds, to show the supply temperature. Check that the temperature is reasonable buy carefully touching the supply pipe.

2. **Flashing temperature and no EXT above the clock.**

The temperature flashing is the set point according to room compensation and the room thermostat controls the heating without the outdoor temperature sensor.

Press ones more on the Info-button, within 3 seconds, to see the value of the outdoor sensor.

3. **EXT above the clock and ---- instead of the outdoor temperature.**

This means that the outdoor sensor or its cable is damaged or not connected.

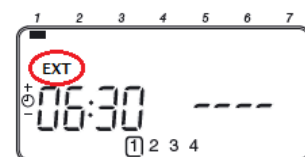









Press ones more on the **Info**-button, in 3 seconds, to show the supply temperature. Check that the temperature is reasonable buy carefully touching the supply pipe.

8.3 Holiday function

The holiday function allows you to set a constant temperature (default = 10°C) for a specified number of days (from 1 - 99 days). This saves energy and related costs when the house is empty, but resumes normal operation on the day of return.

To set the Holiday function:

1. Ensure the room thermostat is running in **AUTO** or **MAN** operating modes.
2. Press the holiday  button to display the holiday day's counter and temperature setting, along with the holiday indicator .
3. Press the   or  time buttons to set the holiday time (1-99 days) and press the green  button to confirm.
4. Press the  or  buttons to set the holiday temperature (5°C - 35°C) and press the green  button to confirm.

The room thermostat will now control to the new temperature for the set number of days that the home is vacant. At midnight, the holiday counter will be reduced by one until the selected number of days have passed. The room thermostat will then return to former operation as set by the **MAN** or **AUTO** mode.

To cancel the HOLIDAY function or to exit the function at any time: press the  button a second time.

8.4 OTC heating curve

The CM737 controls the indoor temperature as a function of the measured outside air temperature. The heating curve is the ratio between the measured outside air temperature and the calculated supply water temperature.

The ideal heating curve is dependent on the type of installation (radiators, convectors, etc.), the thermal properties and the location of the property. A heating curve ratio of 1 to 40 can be set. The figure shows several heating curve ratios for a room temperature setting of the 20°C **without** room temperature compensation.

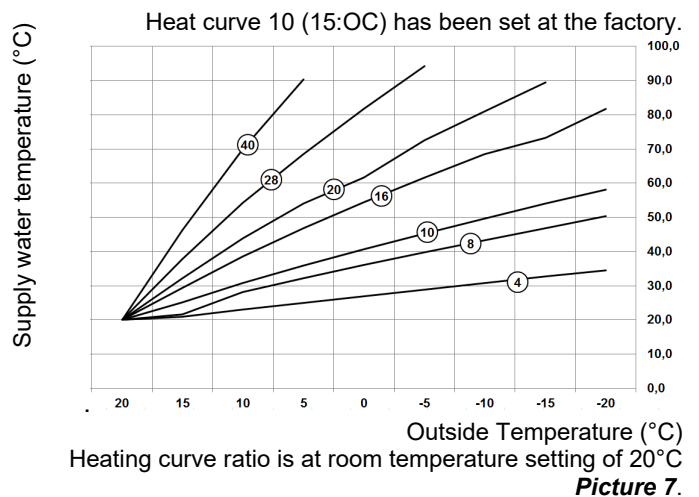

8.5 Parallel adjustment of heating curve

If any other room temperature set point than 20°C is used the selected curve will be parallel compensated.

Every change of the room temperature set point from 20°C will change the supply temperature with approximately 3°C. If the room temperature set point is increased from 20°C to 21°C the supply temperature will increase with approximately 3°C.

This example shows parallels of curve 10 by 19°C and 21°C.

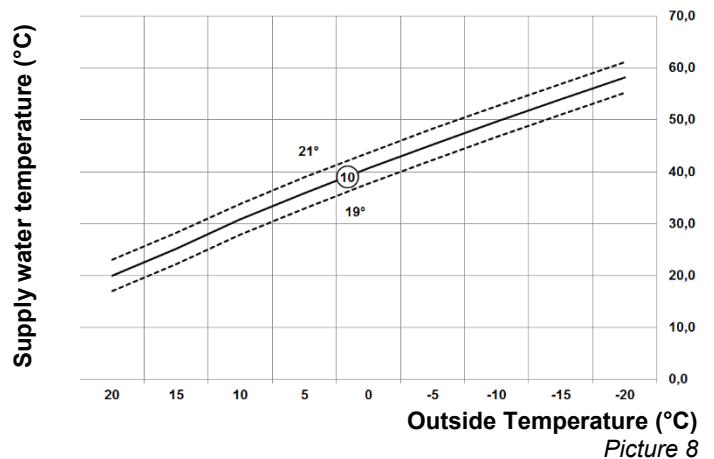

8.6 Operating mode Auto

8.6.1 The Built-in Heating Program

The built-in heating program has four temperature level changes per day that can be set between 3.00am and 2.50am the following day - allowing the evening temperature to maintain after midnight. Each temperature level can be set between 5°C and 35°C, and adjusted in 0.5°C increments.

The factory default program for heating is as:

Monday to Friday (Day 1 to 5)

Period	1	2	3	4
Time	6:30	8:00	18:00	22:30
Temperature	21 °C	18 °C	21 °C	16 °C

Saturday & Sunday (Day 6 & 7)



Period	1	2	3	4
Time	6:30	8:00	18:00	22:30
Temperature	21 °C	18 °C	21 °C	16 °C

8.6.2 Reviewing the Heating Program

To review or edit the heating program use the **PROGRAM**  or  buttons to navigate between the four individual programming periods.

Use the **DAY** button to step through each day of the week, so the complete 7-day heating program can be reviewed or edited.

8.6.3 Temperature Override





During **AUTO** mode, the programmed temperature can be adjusted manually. The 'target' temperature will be displayed and flash for 5 seconds - during this time the  or  or buttons can be used to modify the set value.

NOTE: This temperature override is cancelled at the next programmed temperature change.

8.6.4 Disabling/enabling time periods

Any of the heating period from 2 to 4 can be removed from (or returned to) the heating program profile.

To disable or enable time periods:

- To disable unwanted periods, go to the desired period (2 to 4) using the **PROGRAM**  or  buttons to navigate, ensure the correct period is highlighted with the flashing square symbol. Press and hold the  button for at least 2 seconds and the display will indicate the period has been removed from the program.
- To enable periods again, follow the same procedure as above, navigating to the already disabled period. To enable this period again, press and hold the  button for at least 2 seconds.



8.6.5 Modifying the heating program

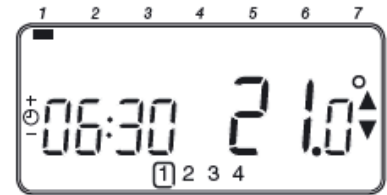

To change the heating program:

- a) Press either of the **PROGRAM**  or  buttons to enter the programming mode.

The time /temperature settings for period  on Monday day 1 will be flashing. The active period is highlighted by a flashing square around the numbers at the bottom of the screen and the selected day is shown with the day indicator.







- b) To adjust the period, start time use the   or  buttons, the 'OK?' indicator will be displayed to confirm the change. Holding the button down will change the time quickly.

Note: If you are pressing the   or  buttons and the display flashes the next period, it means the next period will be pushed forward.



- c) Once the required time is reached press the green  button to confirm.

Note: If the original time setting did not require adjustment press the green  button to move to step 'd'.

- d) The temperature setting for period  on Monday (Day 1) will now be flashing. To adjust this, press the  or  buttons and confirm the setting again by pressing the green  button.

- e) The next time and temperature period will now be active. Adjust this by repeating steps b - d above until all four periods are set or press the **AUTO** button to run the program as set, at any time.

Chose how to set the program for the next day:

- f) Press the **COPY DAY** button to copy Monday's program into Tuesday. The display will go blank apart from the 'non-flashing' day indicator, which indicates the day copied and the 'flashing' target day to copy the program to. To accept this day, press the green  button. To select a different target day press the **DAY** button until the 'flashing' day indicator is under the required day, and then accept it by pressing the green  button.

Note: Once the target day is confirmed it becomes the day that is copied if the **COPY DAY** button is pressed again.

Or

Press the **DAY** button to move the day indicator to Tuesday (Day 2). The program for that day can then be adjusted by following steps b to e. Programs for the remaining days can be set in the same way, using the **DAY** button to move to the next day.

To exit the programming mode, select the desired operating mode by pressing the **AUTO**, **MAN** or **OFF** buttons.

Note: To run the adjusted program; select the **AUTO** mode.

9 Activation of installer parameters

Installer Mode is used to alter the system settings for specific applications, to use the special features of the room thermostat in a different way or to alter the factory present parameters. Parameters are divided into groups:

- Category 1 parameters: Control panel settings
- Category 2 parameters: ECO-functions
- Category 3 parameters: Setting and displaying sensor values
- Category 4 parameters: Heating actuator settings
- Category 5: Fault History

9.1 Entering the installer set-up mode

1. Press the **OFF** button.
2. Press and hold the **i** button and the two **PROGRAM** (◀) and (▶) buttons together.
3. The unit will display the first parameter of installer parameter group category 1.
4. Press the **▲** or **▼** button to change the factory setting.
The display will flash indicating that a change has been made.
5. Press the green **OK** button to confirm the change. The display will stop flashing.
6. Press the **⌚** (+) button to go to the next parameter.
7. Press the **PROGRAM** (▶) button to go to the next parameter category.
8. To exit installer mode, press the **AUTO**, **MAN** or **OFF** button.

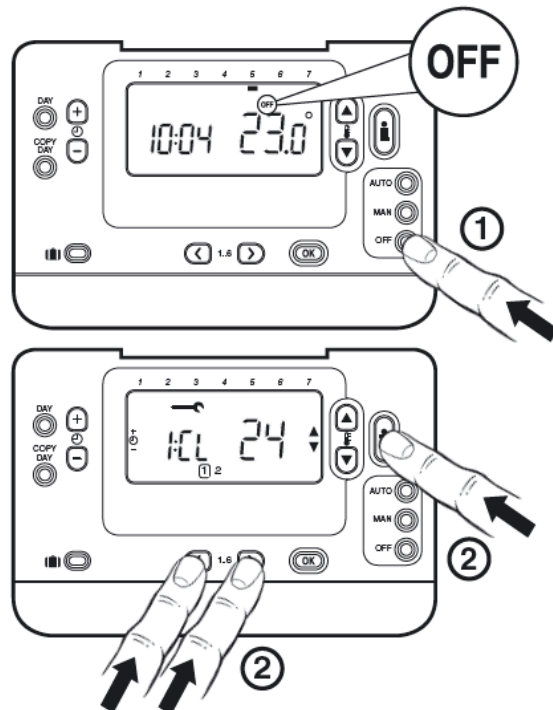

Picture 9
Abbreviated Set-Up Description
e.g. Cl=Clock Format

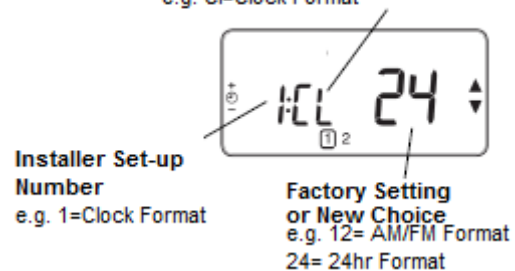

Picture 10

9.2 Category 1 parameters: Control panel settings

Parameter	Parameter N:o	Factory Default Setting		Optional Setting	
		Display	Description	Display	Description
AM-PM / 24hr Display	1:CL	24	24 hr. clock display format	12	12 hr. – AM/PM clock display format
Reset Time/ Temp Program	2:rP	1	Time/temperature profile set to factory default. Changes to 0 when one of the time/temp profiles are changed.	0	Factory Time / Temperature profile has been modified To restore the factory profile set to 1
Upper Temp Limit	6:uL	35	35°C Upper Temp. Limit	21 to 34	21°C to 34°C, adjustment in 1°C steps
Lower Temp Limit	7:LL	5	5°C Lower Temp. Limit	6 to 21	5°C to 21°C, adjustment in 1°C steps
Temperature Offset	12:tO	0	No temperature offset	-3 to +3	-3°C to +3°C, adjustment in 0.1°C steps
Proportional Band Width	13:Pb	1.5	Proportional band of 1.5 degree	1.6 to 3.0	1.6°C to 3.0°C, adjustment in 0.1°C steps
Room control / OTC ¹⁾	14:rC	0	Room temperature control (thermostat)	1 or 2	1 – OTC control without room temperature compensation 2 – OTC control with room temperature compensation
OTC heat curve	15:OC	10		1 to 40	1 to 40, adjustment in steps of 1
Reset Parameters to Factory Defaults	19:FS	1	All settings at factory defaults Changes to 0 when one of the parameter is changed	0	Settings are as modified above. To restore the factory parameters set to 1

9.3 Category 2 parameters: ECO-functions

Parameter	Parameter N:o	Factory Default Setting		Optional Setting	
		Display	Description	Display	Description
Summer heating in OTC mode	1:SH	0	Summer heating disabled	1 to 40	Minimum set point for the heating and the pump will be held on.
Summer reduction	2:SL	20	The outside temperature at which the heating will switch off	10 to 30	The economy function will be disabled if the setting for summer heating is not 0
Economy function	3:Pd	10	Diff between outside and calculated water supply temperature		If the calculated water supply temperature is not greater than the outside temperature by this amount the heating will switch off.

9.4 Category 3 parameters: Setting and displaying sensor values

Parameter	Parameter N:o	Factory Default Setting		Optional Setting	
		Display	Description	Display	Description
Maximum central heating set point ²⁾	1:CH	90	90°C or obtained from the boiler	40 to 90	40°C to 90°C adjustment in 1°C steps
DHW set point ²⁾	2:HS	55	55°C or obtained from the boiler	40 to 80	40°C to 80°C adjustment in 1°C steps
Supply water temperature ³⁾	3:St	Actual temp	Temperature obtained from the connection box (between 0°C and 99°C)	N/A	Not applicable
Return water temperature ³⁾	4:rt	Actual temp	Temperature obtained from the connection box	N/A	Not applicable
DHW temperature ³⁾	5:Ht	Actual temp	Temperature obtained from the connection box	N/A	Not applicable
Outside temperature ⁴⁾	6:Ot	Actual temp	Between -30°C and 99°C	N/A	Not applicable
Water pressure ³⁾	7:Pr	Actual press	Between 0.0 bar and 4.0 bar	N/A	Not applicable
DHW storage overnight	8:HO	1	DHW storage enabled after last period of day	0	DHW storage disabled after last period of day
DHW storage during HOLIDAY	9:HH	0	DHW storage disabled during HOLIDAY	1	DHW storage enabled during HOLIDAY
Low capacity control	10:LD	1	Not applicable	0	Not applicable

9.5 Category 4 parameters: Heating actuator settings

Parameter	Parameter N:o	Factory Default Setting		Optional Setting	
		Display	Description	Display	Description
P_heat	1	0	Proportional band		1K
I_heat	2	1	Integral factor		0.1 / minute
Run time valve	3	15	Time needed to open or close valve completely		10 seconds

9.6 Category 5: Fault History





Parameter	Parameter N:o	Factory Default Setting		Optional Setting	
		Display	Description	Display	Description

In this category, the occurred errors can be viewed, beginning with the most recent error.

- ¹⁾ Only if the setting is allowed by the heating appliance. Standard settings and limits can be set by the heating appliance.
- ²⁾ Only available if supported by the heating appliance.
- ³⁾ Only available if the outside temperature sensor is mounted.
- ⁴⁾ Category 4 & 5 parameters are only available if supported by the heating appliance. This will depend on the type of boiler electronics in the heating appliance connected with the control panel.

Notes: Always remember to press the green  button to confirm new Installer Set-Up setting. To exit the Installer Set-Up Mode press the **AUTO** or **MAN** button.

10 Troubleshooting the control panel

Symptom	Possible Cause	Remedy
A flashing  symbol appears on the display within one minute after the control panel being powered on.	The control panel receives power supply from the connection box, but no information.	The control panel is not connected to the correct terminals of the connection box.
A  symbol appears permanently (no flashing) on the display.	Communication error due to an interrupt or short circuit in the link between the connection box and the control panel.	The control panel is not connected to the correct terminals of the connection box. Contact Cetetherm.
Display is blank	No power feed after the installation of the control panel.	Check that the power supply cable of the connection box is connected. The control panel is not connected to the correct terminals of the connection box
	The power supply or the communication link between the control panel and the connection box has been interrupted for more than 8 hrs.	Check that the power supply cable of the connection box is connected. After the power is restored the time and day may need to be adjusted – otherwise contact your service technician.
A flashing  symbol appears on the display after the control panel being operating for a period	The control box is showing an error	Press the  button, to see the error code. See 10.1 Fault codes on the control panel .
A flashing  symbol appears on the display and the room temperature is replaced by “—“	Internal fault in the temperature measuring circuit.	Contact your service technician.

10.1 Fault codes on the control panel

If a spanner is visible on the display, there is an on ongoing alarm. Press the Info-button to view the fault code.

Error source	Error code
No fault (power-up)	0
Supply water temperature sensor or cable	1
Outside air temperature sensor out of range	2
Temperature in the connection box out of range	3
Cannot reach the set supply temperature	4
No communication between control panel and connection box	7

Fault code 0 This fault code can just be seen in the fault history, parameter settings category 5.
Not via the Info- button.

Fault code 1 Supply sensor or cable
Cause Measured supply water temperature is below 0°C or above 100°C.
Actions The control panel turn the pump off, and enter off mode (frost protection).
Check the supply sensor and its cable.

Fault code 2 Outside sensor out of operating range. This fault code can only occur after the measured outside temperature has been in range: -40°C to 60°C.
Cause Measured outside temperature is below -40°C or above 60°C
Actions Enter room compensation until a valid temperature has been measured.
Check the outside sensor and its cable.

Fault code 3 Connection box temperature out of operating range
Cause Measured environment temperature is below -0°C or above 60°C.
Actions The control panel turn the pump off, and enter off mode (frost protection).
Make sure that the substation is mounted in a well vented room.

Fault code 4 Cannot reach the set supply water temperature
Cause Air in the pump, low temp/ not district heating supply.
Actions Vent the pump, check the control valve and actuator.

Fault code 7 No communication between control panel and connection box
Cause The connection box does not communicate with the control panel (by OT) for 60 seconds.
Actions Fault is only cleared after a power break and OT communication is working again.
Check the control panel cable.

11 Electrical circuit diagram

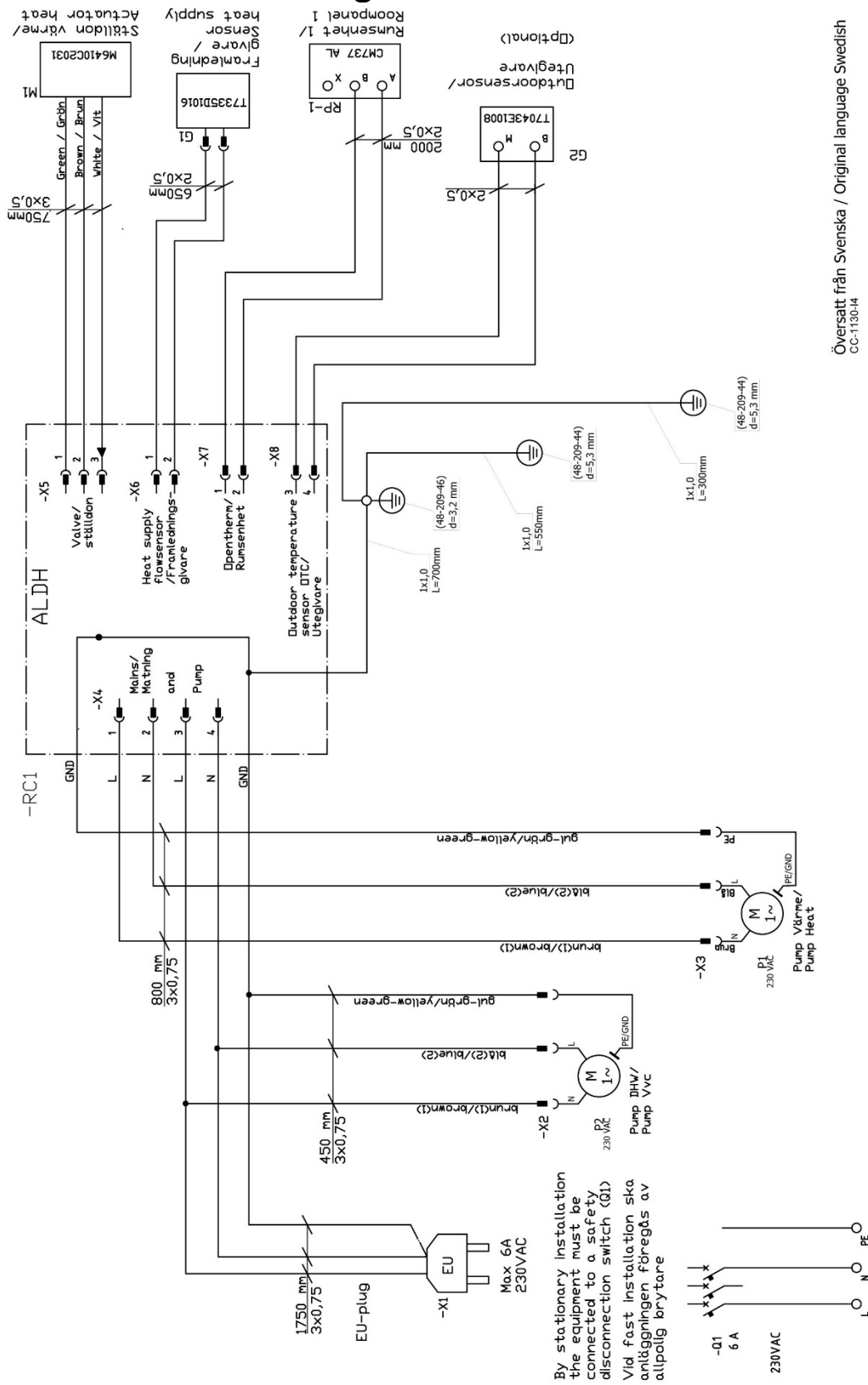

Översatt från Svenska / Original language Swedish
 CC-1130-14

Picture 11

12 Schematic diagram, main components

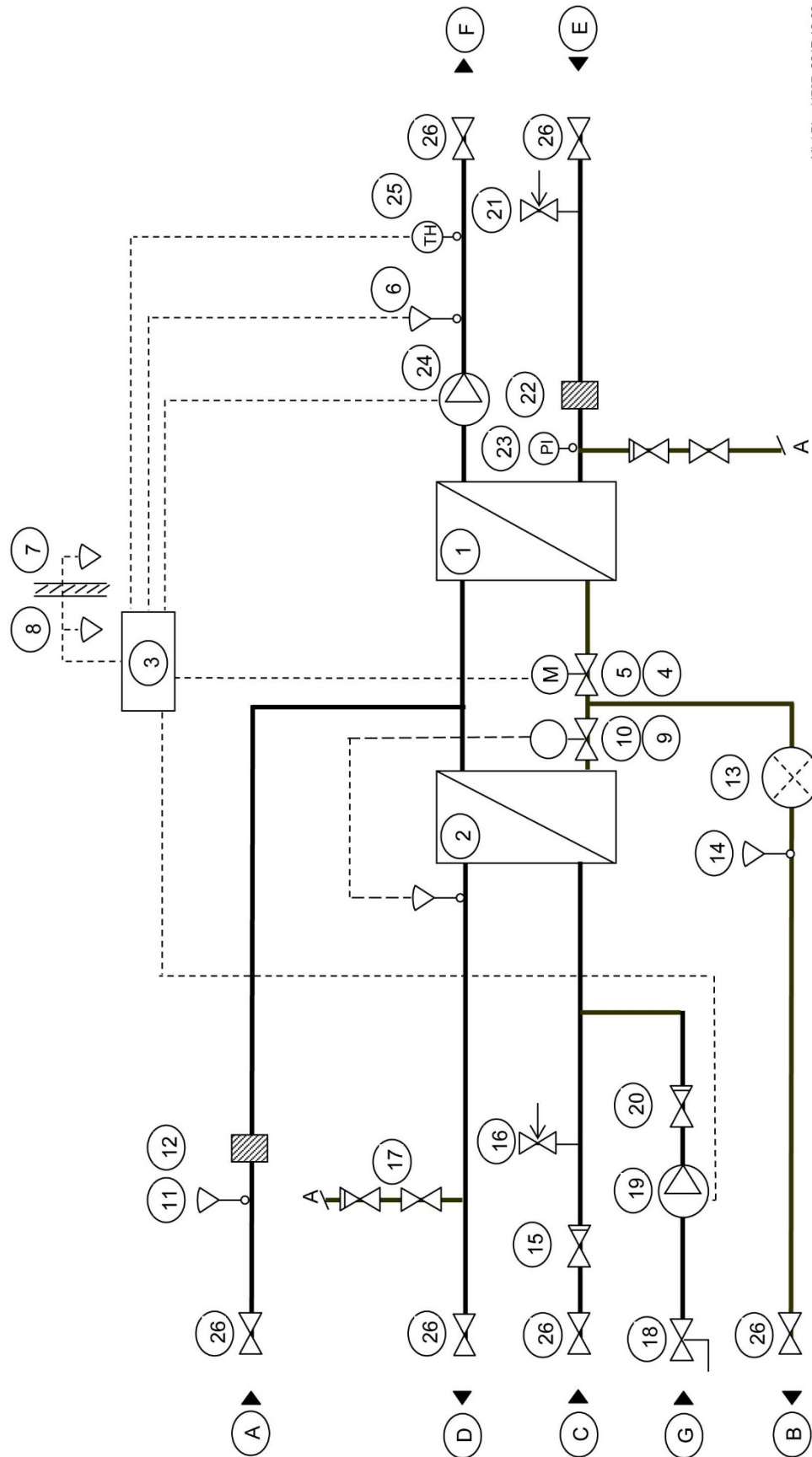

Mini Plus H737 2017-10-03

Picture 12

13 Pump settings and pump performance

13.1 General

Mini Plus is equipped with two circulation pumps, one for the hot water circulation, DHWC-pump, and one for the heating circuit.

The DHWC pump is a traditional three speed circulation pump. The DHWC pump has a switch where the speed/capacity can be set.

Mini Plus can be equipped with two different circulation pumps for heating circuit. Both are a pressure controlled pump.

13.2 DHWC-pump Grundfos UPSO 15-55

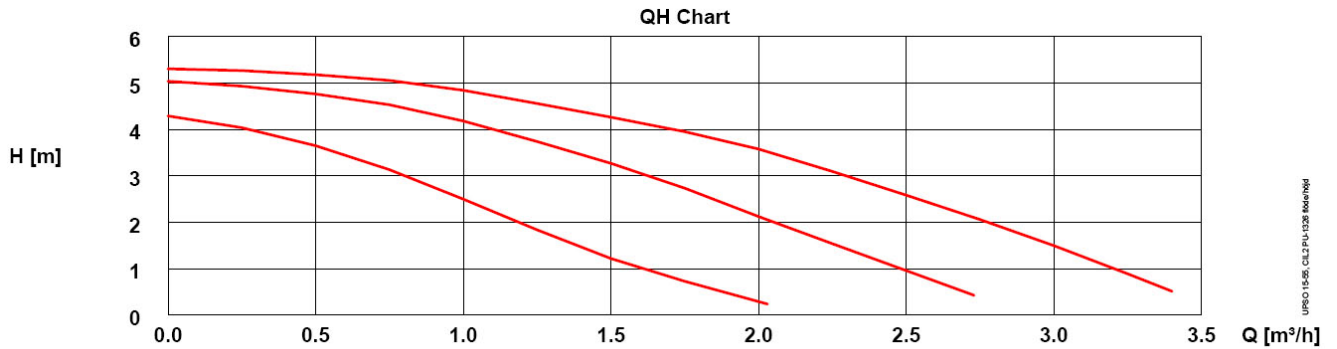

Picture 13

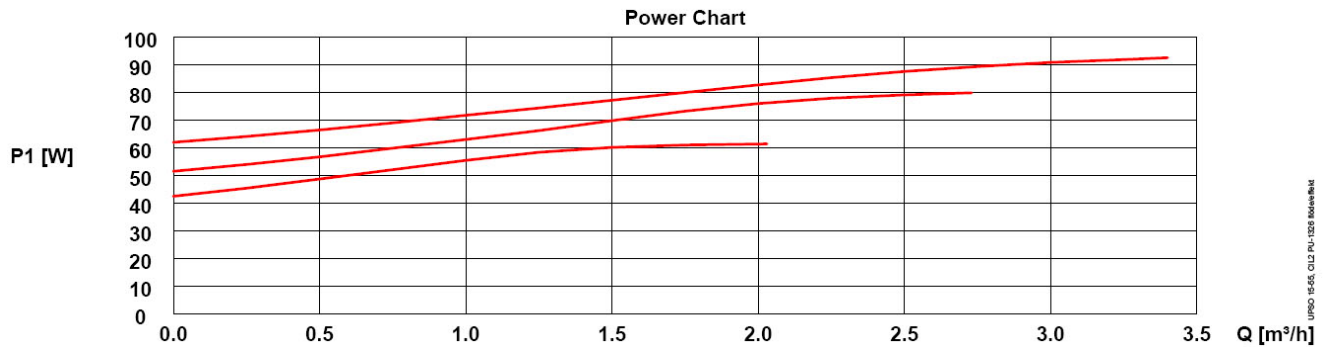

Picture 14

13.3 Heating circuit pump Grundfos UPM3 Auto L 50-70 130

When the pump is switched on it runs with the factory pre-setting or the last setting.
The pump is pre-set to run with operation mode, proportional pressure mode 2, PP2.

Operation mode indicates with LEDs on the pump front.

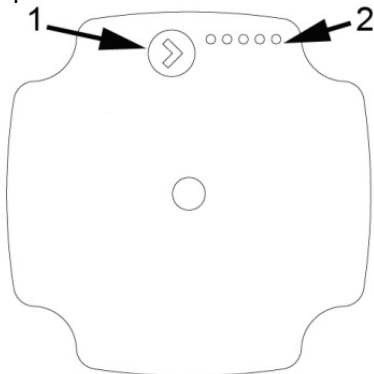

- 1 Push button
- 2 LEDs

Settings	Pump curve	Function
PP1		Proportional-pressure curve The head (pressure) is reduced at falling heat demand and increased at rising heat demand.
PP2		The duty point of the pump will move up or down on the selected proportional-pressure curve, depending on the heating demand.
PP3		
CP1		Constant-pressure curve The head (pressure) is kept constant, irrespective of the heating demand.
CP2		The duty point of the pump will move out or in on the selected constant-pressure curve, depending on the heating demand in the system.
CP3		
CC1		Constant curve The circulator runs on a constant curve, which means that it runs at a constant speed or power.
CC2		The duty point of the circulator moves up or down on the selected constant curve, depending on the heat demand in the system.
CC3		
CC4		

13.3.1 Pump curve proportional pressure mode 2, PP2

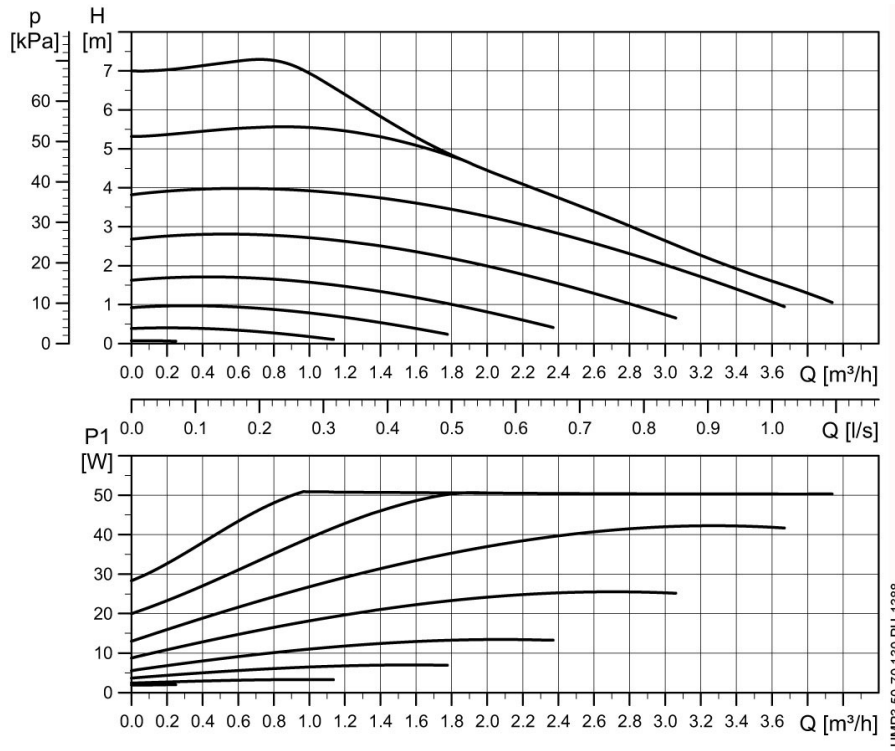

Line type	Description
	Constant Curve
	Proportional Pressure
	Constant Pressure

13.3.2 Change pump operating mode

The display shows the current operation status.

- Press the button for more than 2 seconds and the circulator switches to "setting selection". The LEDs flash and show the current setting mode. Please note that if the key lock is disabled, the circulator will not switch to "setting selection". In this case, unlock the key lock by pressing the button for more 10 seconds.
- To select between the settings, instantly press the button until you find the setting you want. If you pass a setting, you need to continue until the setting appears again as it is not possible to go back in the settings menu.
- Release the button for more than 10 seconds and the user interface switches back to the performance view and the last setting is stored.

13.3.3 Key lock function

The purpose of the key lock function is to avoid accidental change of settings and misuse. When the key lock function is enabled, all long key presses will be ignored.

Lock and unlock by pressing the key for more than 10 seconds.

13.4 Heating circuit pump Grundfos UPML 25-105 180 Auto, settings and capacity

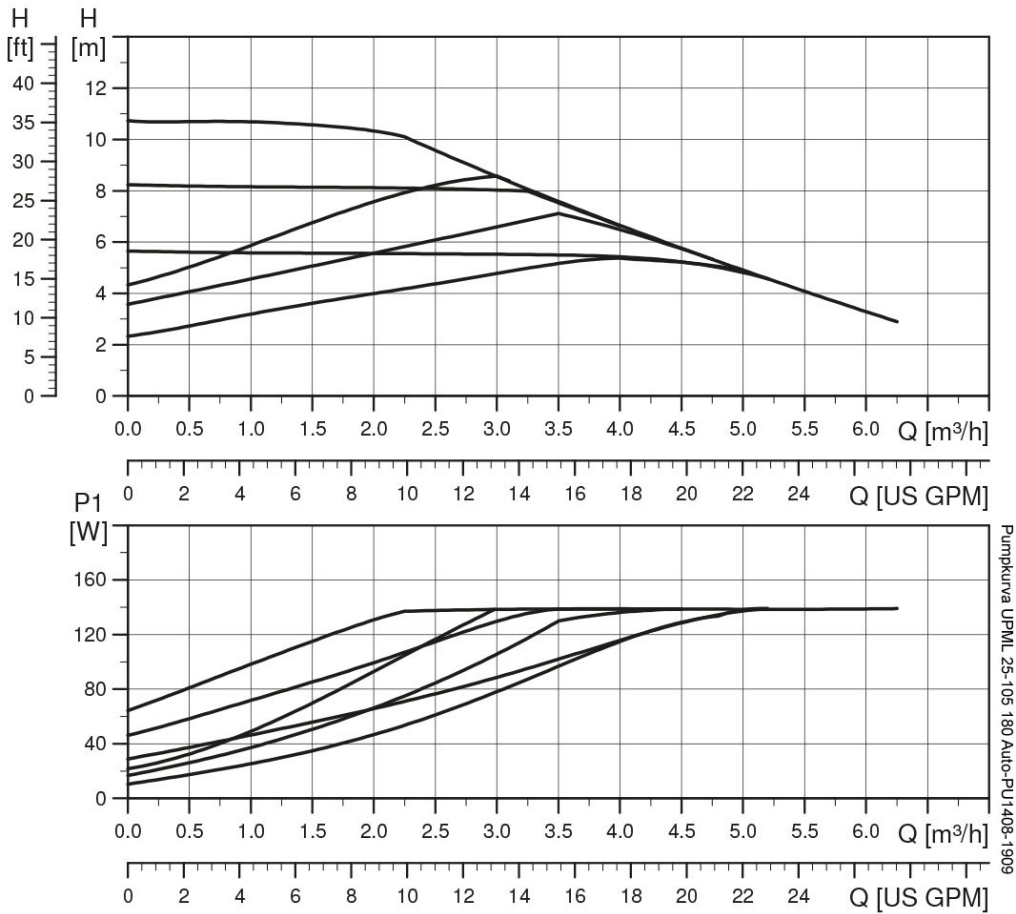

The heating pump is internally controlled via digital pulse-width modulation. The user interface allows to select between six control curves in two control modes:

- three proportional pressure curves (PP)
- three constant pressure/power curves (CP).

The pump is factory preset to Proportional pressure curve, PP2.

Flashing fast III II I	PP1
Flashing fast III II I	PP2
Flashing fast III II I	PP3
Flashing slow III II I	CP1
Flashing slow III II I	CP2
Flashing slow III II I	CP3

Picture 15, LED indication of the curve setting

13.4.1 Changing pump curve setting

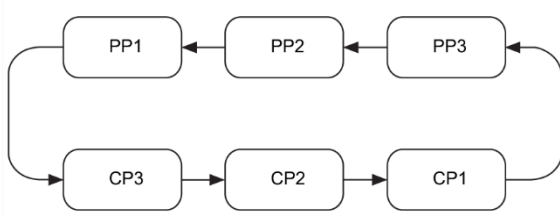

Picture 16, Serial curve setting

1. Push the button for two seconds
Pump goes to setting mode - LED starts flashing.
2. With each push, the setting changes:
LED 1-2-3 are permanently on, and then the control curve and mode is changed.
3. Flashing mode:
 - Fast: Proportional pressure
 - Slow: Constant pressure/power
4. After ten seconds not pushing the button:
 - Setting is adapted.
 - Pump returns to operating mode
5. LED 1 or 2 or 3 is permanently on.
 - Pump is running with the selected curve and mode.

14 Fault finding pump



Before starting any work at the pump, switch off the power supply. Make sure that the power supply cannot be switched on accidentally.

Be aware that capacitors will be live up to 30 seconds after the power supply has been switched off.

Fault	Cause	Remedy
Pump is not running. No power supply	<ul style="list-style-type: none"> • System is switched off. • A fuse in the installation is blown. • The circuit breaker has tripped. 	<p>Check the system controller.</p> <p>Replace the fuse.</p> <p>Check the power connection and switch on the circuit breaker.</p>
Pump is not running. Normal power supply.	<ul style="list-style-type: none"> • Power supply failure. • Controller is switched off. • Pump is blocked by impurities. 	<p>Check the power supply.</p> <p>Check the controller and its settings.</p> <p>Remove impurities. Unblock the pump from the front of the control box with a screwdriver</p>
Noise in the system.	<ul style="list-style-type: none"> • Pump is defective. • Air in the system. • Differential pressure is too high. 	<p>Replace the pump.</p> <p>Vent the system.</p> <p>Reduce the pump performance at the pump or external controller.</p>
Noise in the pump.	<ul style="list-style-type: none"> • Air in the pump. • Inlet pressure is too low. 	<p>Let the pump run. The pump vents itself over time.</p> <p>Increase the system pressure or check the air volume in the expansion tank, if installed.</p>
Insufficient flow.	<ul style="list-style-type: none"> • Pump performance is too low. • Hydraulic system is closed or system pressure is insufficient. 	<p>Check the external controller and the pump settings.</p> <p>Check the non-return valve and filter. Increase the system pressure.</p>

14.1 Fault finding UMP3 pump

Fault	Cause	Remedy
Pump LED5 is on. Pump tries to restart every 1.5 sec.	<ul style="list-style-type: none"> • Rotor shaft is blocked 	<p>Deblock the rotor shaft by pushing it with a screwdriver from the front of the pump.</p>
Pump LED4 is on.	<ul style="list-style-type: none"> • Pump is running. 	<p>Check the supply voltage.</p>
Pump LED3 is on. Pump stops.	<ul style="list-style-type: none"> • Supply voltage is too low. • Serious failure. 	<ul style="list-style-type: none"> • Check the supply voltage. • Exchange the pump.

15 Service instructions



To avoid the risk of scalding, make sure that no-one draws any water while servicing the substation.



Grey marked service actions must be carried out by an authorized service technician.

Note! Make sure that the Mini Plus had been correctly installed.

15.1 Tap water service instructions

15.1.1 Tap water temperature too low

Reason	Action
District heating supply too low	Check the primary inlet temperature The temperature can be checked by means of the energy meter (min 65° C) or at the district heating medium supply.
Handle on control valve incorrectly positioned	Adjust the handle on the control valve The hot water temperature can be controlled by turning the handle, on the control valve for domestic hot water, counter clockwise for increased tap water temperature. To decrease tap water temperature, turn the handle clockwise, until the desired tap water temperature is reached (55° C approx.). The stabilisation time for the hot water temperature is about 20 seconds.
District heating filter clogged	See 17.1 Cleaning the district heating filter
Hot water valve does not work	See 16.1 Check the function of the valve for hot water .
Balancing valve DHWC may need to be adjusted	Check and adjust the DHWC balancing valve Check that the balancing valve is open enough

15.1.2 Tap water temperature too high

Reason	Action
Handle on control valve incorrectly positioned	Adjust the handle on the control valve The hot water temperature can be controlled by turning the handle, on the control valve for domestic hot water, counter clockwise for increased tap water temperature. To decrease tap water temperature, turn the handle clockwise, until the desired tap water temperature is reached (55° C approx.). The stabilisation time for the hot water temperature is about 20 seconds.
Hot water valve and/or actuator does not work	Check the valve according to 16.1 Check the function of the valve for hot water . If the water temperature is too high when the handle is in position 0, the actuator or the exchanger is damaged and requires replacing.

15.1.3 Hot water temperature unstable

Reason	Action
Alternating pressure on primary side	Check available differential pressure and temperature at the district heating medium supply.
District heating filter clogged	See 17.1 Cleaning the district heating filter
DHWC pump is not running	Check that the electrical power is on If the pump fails to start after stopping, try to start it at the highest setting. See 16.3 Check the circulation pump Grundfos UPS .
Balancing valve DHWC may need to be adjusted	Check and adjust the DHWC balancing valve Check that the balancing valve is open enough
Check valve DHWC is damaged	Check and change if required, see 17.11 Change the DHWC check valve .

15.1.4 Noise in the DHWC system

Reason	Action
The pump capacity is set too high	Reduce the pump capacity The pump has been set at a too high capacity level. Reduce the level by choosing a lower output setting on the pump. The lowest setting is the most economical.
Air in the pump	Vent the pump Set the pump to speed III. Loosen the pump motor end nut to and let it stay opened until the air in the pump is released. When the pump has been vented, i.e. when the noise has ceased, set the pump according to the recommendations.
The pump motor or pump component damaged	See 17.3 Change the complete DHWC pump or pump components.

15.2 Heating system service instructions

15.2.1 Heating system temperature too high or too low

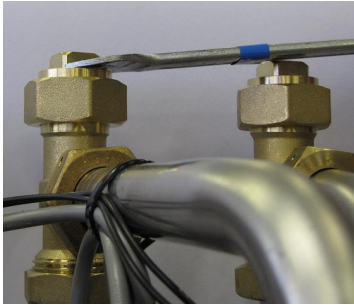
Reason	Action
The pressure in the system is too low or there is not enough water in the heating system	Check the pressure on the manometer and top up the system with water The pressure should not be below 1.0 Bar in winter time or below 0.6 Bar in summer. The circuit should only be topped up with fresh water when necessary. The water used for topping up contains oxygen which can lead to corrosion in the system. The circuit should therefore be topped up as seldom as possible. Fill up by opening the top up valves until the pressure meter shows desired value, or up to maximum 2.0 Bar. Then close the top up valve. The safety valve opening pressure is 2.5 Bar.
Air in the heating system	Bleed the heating system Bleed the heating system at highest point in the heating system. The pump is self-venting. Air in the pump may cause noise. This noise ceases after a few minutes run time. Bleed the radiators.  Picture 17
Heating supply temperature sensor and outdoor temperature sensor does not work	Check the heating supply temperature sensor and outdoor temperature sensor Check that they are correctly sited and working. To confirm that sensors are connected and operating, press the info button on the operator control panel, check that the specified temperatures are reasonable.
Heating circuit filter clogged	See 17.2 Cleaning the heating circuit filter.

Reason	Action
The heating control equipment may need to be adjusted	<p>Check and adjust the heating curve See 9.2 Category 1 parameters: Control panel settings and change the selected heating curve with parameter 15 category 1.</p> <p>If needed the set heating curve can be fine-tuned. Increase/decrease the room temperature to parallel adjust the heating curve.</p> <p>Also see section 8.4 OTC heating curve and 8.5 Parallel adjustment of heating curve.</p>
Heating valve and actuator does not work	See 16.2 Check the heating actuator and valve function .

15.2.2 No heating

Reason	Action
Circulation pump not running	<p>Check that the electrical power is on</p> <p>Check the heating circulation pump If the pump fails to start after stopping, try to start it at the highest setting. If a UPM3 pump see 14 Fault finding pump.</p>
	<p>Check the heating parameters in operator control panel Summer reduction, parameter 2, category 2: If measured outdoor temperature is higher than target temperature, the pump should not be operating.</p> <p>Economy function, parameter 3, category 2: If the calculated water supply temperature is not greater than the outside temperature by this amount the heating will switch off. If parameter 3 is 0, the pump operation will not be affected by this parameter.</p>
The pressure in the system is too low or there is not enough water in the heating system	<p>Check the pressure on the manometer and top up the system with water The pressure should not be below 1.0 Bar in winter time or below 0.6 Bar in summer. The circuit should only be topped up with fresh water when necessary. The water used for topping up contains oxygen which can lead to corrosion in the system. The circuit should therefore be topped up as seldom as possible. Fill up by opening the top up valves until the pressure meter shows desired value, or up to maximum 2.0 Bar.</p> <p>Then close the top up valve. The safety valve opening pressure is 2.5 Bar.</p>

Reason	Action
Air pockets in the substation or in the heating circuit	<p>Bleed the heating system Bleed the heating system at highest point in the heating system.</p> <p>The pump is self-venting. Air in the pump may cause noise. This noise ceases after a few minutes run time. Bleed the radiators.</p>  <p><i>Picture 18</i></p>
Heating supply temperature sensor and outdoor temperature sensor does not work	<p>Check the heating supply temperature sensor and outdoor temperature sensor Check that they are correctly sited and working. To confirm that sensors are connected and operating, press the info button on the operator control panel, check that the specified temperatures are reasonable.</p>
Loss of function in the heating control unit.	See 16.4 Run the pump manually.
Heating circuit filter clogged	See 17.2 Cleaning the heating circuit filter

15.2.3 Heating system often needs topping up

Reason	Action
Leaks in the substation or in the system	<p>Check the substation and the system for leaks Leaks from the substation or the heating system cause pressure drop. Contact your service technician if finding any leaks.</p>
The heating system safety valve is leaking or does not work	<p>Check the heating system safety valve Check that the heating system safety valve is not leaking and that it works properly. Check the safety valves' function by turning the red wheel/knob until water runs out of the valve's waste pipe and then close the valve quickly.</p>
The expansion vessel cannot handle the changes in the system	See 16.5 Check the volume take-up and pressure equalizing of the expansion vessel

15.2.4 Heating temperature unstable

Reason	Action
Alternating pressure on primary side	<p>Check available differential pressure and temperature at the district heating medium supply.</p>
District heating filter clogged	See 17.1 Cleaning the district heating filter.
Heating supply temperature sensor and outdoor temperature sensor does not work	<p>Check the heating supply temperature sensor and outdoor temperature sensor Check that they are correctly sited and working. To confirm that sensors are connected and operating, press the info button on the operator control panel, check that the specified temperatures are reasonable.</p>

15.2.5 Noise in the radiator system

Reason	Action
The pump capacity is set too high	Reduce the pump capacity Reduce the level by choosing a lower output setting on the pump.
Air in the pump	Vent the pump The pump is self-venting. Air in the pump may cause noise. This noise ceases after a few minutes run time.
The pump motor or pump component damaged	See 17.4 Change the complete heating pump or pump components.

16 Service actions for the installer

16.1 Check the function of the valve for hot water



Service actions must be carried out by an authorized service technician.



Close the shutoff valves for the **DH supply** and **DH return** together with the **cold** and **hot water**.



After finishing repair; open the shutoff valves. Start with **DH supply** and then the **return** line, to avoid pollutions in the system. Open the valves slowly to avoid pressure surges.

1. Disconnect the power feed to the substation.
2. Close the shut-off valves.
3. Unscrew the tap water actuator from the control valve.

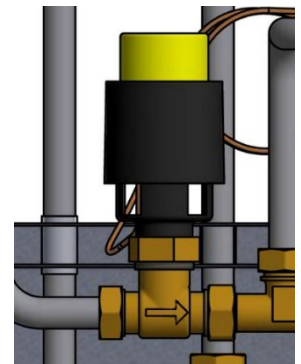

Picture 19

4. Carefully press the valve's spindle with a tool and check the valve's travel and spring back.

NOTE: The valve may be very hot!

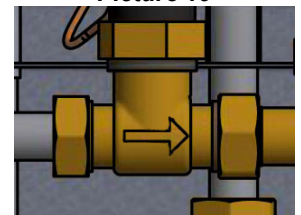

Picture 20

5. Turn the handle on the actuator; a small dip should move in and out. If the dip does not move the actuator is damaged and requires replacing.
6. Connect the power feed to the substation.
7. Open the shutoff valves.

16.2 Check the heating actuator and valve function



Service actions must be carried out by an authorized service technician.



The control panel must be without current when maneuvering the actuator by hand.

Check the actuator by pulling out the electrical cable and refit it again; this will start an automatic self-test for the actuator.
See [7.3 Starting up and component control of control panel](#).
Check the flow using the energy meter while test-running the valve.

If no energy meter is available, disconnect the heating actuator from the valve. Close the actuator by turning the knob clockwise, this will make it easier to reattach.

Carefully depress the valve's spindle with a tool and check the valve's travel and spring back.

NOTE! The valve may be very hot!

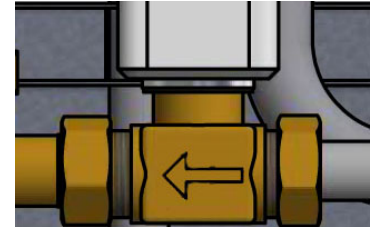

Picture 21

16.3 Check the circulation pump Grundfos UPS

If the pump fails to start after stopping, try to start it at the highest setting.



Service actions must be carried out by an authorized service technician.



Disconnect the power feed to the pump by pulling off the connector before carrying out this task. If the current is on when you use a screwdriver to assist the pump to start, the screwdriver may be wrenched out of your hand when the pump starts.

If the pump does not start, the pump normally can be started by removing the pump motor end nut and helping the pump to start with the aid of a screwdriver in the notch on the engine shaft.

If possible, use a short screwdriver. If the pump is difficult to access, disconnect the heating actuator.

Connect the power feed to the pump and try to start again.

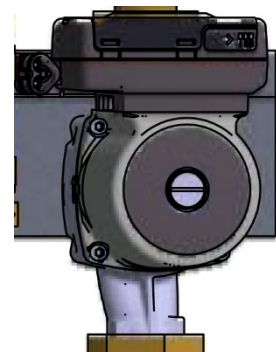

Picture 22

16.4 Run the pump manually



Service actions must be carried out by an authorized service technician.



Hand maneuver of the heating actuator
The room thermostat must be without current when maneuvering the actuator by hand.

If it necessary to run the pump and actuator manually, this can be done by disconnecting the power to the operator control panel.

1. Disconnect the power feed to the substation and the power cable to the pump.
2. Connect the replacement cable (option) to the circulation pump.
3. Open the heating valve manually by turning the actuator knob counter clockwise.
Open the control valve sufficiently to satisfy the heating needs.
4. Connect the power feed to the substation.

Note! This is a temporary solution until the control unit problem is solved.

16.5 Check the volume take-up and pressure equalizing of the expansion vessel

Check the expansion vessel for possible leakage.

The cause may be that the expansion vessel cannot manage the volume changes on the heating side. The expansion vessel may have to be replaced.

See [17.12 Change the expansion vessel](#).

Alternatively, the system's total volume of water may be too high, i.e. the volume changes are too large for the expansion vessel. If so, add extra expansion volume.

17 Maintenance and repairs

When carrying out repairs, please contact your local service partner.



Before starting out repairs always close the correct shutoff valves.



When dismantling a component there will be water coming out, hot and under pressure.

17.1 Cleaning the district heating filter



Service actions must be carried out by an authorized service technician.



The temperature and the pressure of the district heating water are very high. Only qualified technicians can work with the district heating substation. Incorrect operation may cause serious personal injury and result in damage to the building.



Before starting out repairs close the **DH supply** and **DH return** shutoff valves.



After finishing repair; open the shutoff valves. Start with **DH supply** and then the **return** line, to avoid pollutions in the system. Open the valves slowly to avoid pressure surges.

1. Disconnect the power feed to the substation.
2. Close the shut-off valves.
3. Use a wrench and release the filter cover and remove the cartridge.
4. Clean the filter with water and refit the cartridge. Screw the filter cover with a momentum of 10-20 Nm.
5. Open the shutoff valves and connect the power feed to the substation.

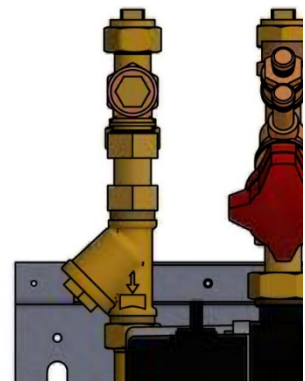

Picture 23

17.2 Cleaning the heating circuit filter



Service actions must be carried out by an authorized service technician.



Before starting out repairs, close the shutoff valves **DH supply**, **DH return**, **heating supply** and **heating return**.
Release the pressure using the heating circuit safety valve.



After finishing repair, fill up the circuit and vent.
Then open the shutoff valves, start with **DH supply** and then the **return** line, to avoid pollutions in the system.
Then open **heat return** and then **supply**.
Open the valves slowly to avoid pressure surges.

1. Disconnect the power feed to the substation.
2. Close the shut-off valves.
3. Use a wrench and release the filter cover and remove the cartridge.
4. Clean the filter with water and refit the cartridge. Screw the filter cover with a momentum of 10-20 Nm.
5. Fill up the heating circuit using the topping up valve, vent the heating circuit.
6. Open the shutoff valves and connect the power feed to the substation.
7. After final bleeding, the pressure should not be less than 1.0 bar in winter and not less than 0.6 bar in summer.

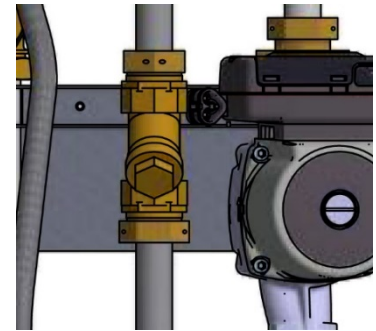

Picture 24

17.3 Change the complete DHWC pump or pump components



Maintenance and repairs must be carried out by an authorized service technician.



Before starting out repairs, close the shutoff valves **DH supply, DH return, cold-water and hot water**.

Note the setting of the balancing valve, then close it.
Release the pressure using the DHWC safety valve.



After finishing repair; fill up the hot water circuit and vent.
Open the shutoff valves, start with **DH Supply** and then **DH return**, to avoid pollutions in the system. Open the valves slowly to avoid pressure surges.



Check the DHWC circulation.

Change the complete pump or just the pump motor.

1. Disconnect the power feed to the substation, disconnect the power cable to the pump.
2. Close the shut-off valves and the balancing valve.
3. Choose alternative a or b.
 - a) When changing the complete pump, release the brass nuts with a wrench and replace the pump.
Connect the pump cable.
 - b) Only changing the motor, release it by unscrewing four socket head cap screws and replace the motor.
Connect the pump cable.
4. Open the shut-off valves cold-water and hot water.
5. Open and adjust the balancing valve.
6. Vent the circuit by opening a hot water tap.
7. Connect the power feed to the substation.
8. Open the shutoff valves DH Supply and then DH return.

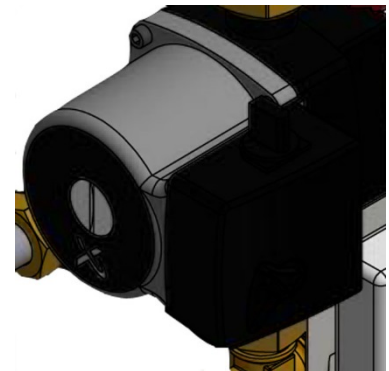

Picture 25

17.4 Change the complete heating pump or pump components



Maintenance and repairs must be carried out by an authorized service technician.



Before starting out repairs, close the shutoff valves **DH supply**, **DH return**, **heating supply** and **heating return**.

Release the pressure using the heating safety valve.



After finishing repair; fill up the **heating circuit** and vent.

Open the shutoff valves, start with **heating return** and then **heating supply**, then **DH Supply** and **DH return**, to avoid pollutions in the system.

Open the valves slowly to avoid pressure surges.

Change the complete pump or just the pump motor.

1. Disconnect the power feed to the substation, disconnect the power cable to the pump.
2. Close the shut-off valves.
3. Choose alternative a or b.
 - c) When changing the complete pump, release the brass nuts with a wrench and replace the pump. Connect the pump cable.
 - d) Only changing the motor, release it by unscrewing four socket head cap screws and replace the motor. Connect the pump cable.
4. Fill up the heating circuit using the top up valves. Vent the heating circuit.
5. Open the shut-off valves and connect the power feed to the substation.
6. After final bleeding, the pressure should not be less than 1.0 bar in winter and not less than 0.6 bar in summer.

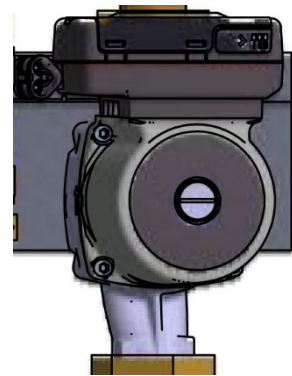

Picture 26

17.5 Change the heating supply temperature sensor

1. Disconnect the power feed to the substation.
2. Close the heating actuator by turning the knob clockwise to its closing position.
3. Disconnect the quick-connect terminals and replace the sensor with a new one.
4. Connect the power feed to the substation.
5. Check the sensors value on the control panel after 5 min.

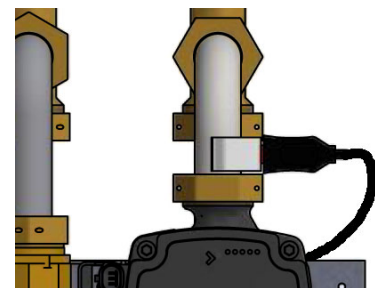

Picture 27

17.6 Change the outdoor temperature sensor

1. Disconnect the power feed to the substation.
2. Close the heating actuator by turning the knob clockwise to its closing position.
3. Unscrew the lid by turning it anti-clockwise.
4. Unscrew the cables.
5. Loosen the cable fitting.
6. Install a new outdoor temperature sensor.
7. Connect the power feed to the substation.
8. Check the sensors value on the control panel after 5 min.



Picture 28

17.7 Change the heating actuator



Maintenance and repairs must be carried out by an authorized service technician.

1. Disconnect the power feed to the substation.
2. At the connection box, disconnect the power cable to the actuator.
3. Unscrew the heating actuator from the valve, the valve closes.
4. Cut off all straps that holds the actuator cable.
5. Make sure that new actuator is closed by turning the knob clockwise to the closing position. Fasten the actuator, use only hand power.
6. Replace cable and straps.
7. Connect the power feed to the substation.
8. Check the function of the actuator during start up.

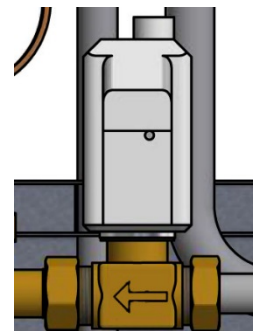

Picture 29

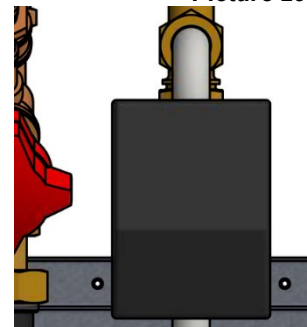

Picture 30

17.8 Change the heating valve



The temperature and the pressure of the district heating water are very high. Only qualified technicians can work with the district heating substation. Incorrect operation may cause serious personal injury and result in damage to the building.



Before starting out repairs close the **DH supply** and **DH return** shutoff valves.



After finishing repair; open the shutoff valves. Start with **DH supply** and then the **return** line, to avoid pollutions in the system. Open the valves slowly to avoid pressure surges.

1. Disconnect the power feed to the substation.
2. Close the shut-off valves.
3. Unscrew the heating actuator from the control valve.
4. Use a wrench to remove the control valve.
Note the arrow direction on the valve.
5. Mount a new valve; and take especially care to the arrow direction.
6. Close the actuator by turning the knob clockwise to the closing position. Fasten the actuator, use only hand power.
7. Open the shutoff valves and connect the power feed to the substation.

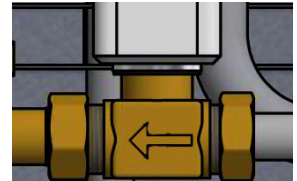

Picture 31

17.9 Change the hot water valve



The temperature and the pressure of the district heating water are very high. Only qualified technicians can work with the district heating substation. Incorrect operation may cause serious personal injury and result in damage to the building.



Before starting out repairs close the **DH supply** and **DH return** shutoff valves.



After finishing repair; open the shutoff valves. Start with **DH supply** and then the **return** line, to avoid pollutions in the system. Open the valves slowly to avoid pressure surges.

1. Disconnect the power feed to the substation.
2. Close the shut-off valves.
3. Unscrew the tap water actuator from the control valve.
4. Use a wrench to remove the control valve.
Note the arrow direction on the valve.
5. Mount a new valve; and take especially care to the arrow direction.
6. Fasten the actuator.
7. Open the shutoff valves and connect the power feed to the substation.

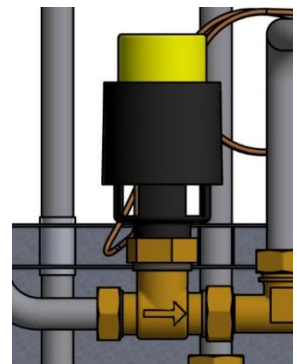

Picture 32

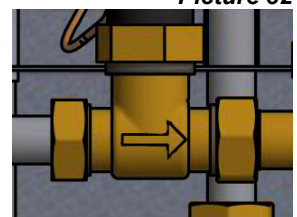

Picture 33

17.10 Change the hotwater actuator and sensor



Maintenance and repairs must be carried out by an authorized service technician.



Before starting out repairs, close the shutoff valves **DH supply**, **DH return**, **cold-water** and **hot water**.

Note the setting of the balancing valve, then close it.
Release the pressure using the DHWC safety valve.



After finishing repair; fill up the hot water circuit and vent.
Open the shutoff valves, start with **DH Supply** and then **DH return**, to avoid pollutions in the system. Open the valves slowly to avoid pressure surges.

8. Disconnect the power feed to the substation.
9. Close the shut-off valves.
10. Unscrew the tap water actuator from the control valve.



Bild 1

11. Disconnect the sensor in the heat exchanger.
12. Mount a new actuator and sensor.
13. Open the shutoff valves cold and hot water.
14. Open and adjust the balancing valve.
15. Vent the circuit by opening a hot water tap.
16. Connect the power feed to the substation.
17. Open the shutoff valves DH Supply and then DH return.

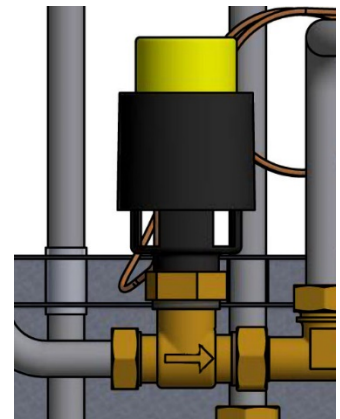

Bild 2

17.11 Change the DHWC check valve



Maintenance and repairs must be carried out by an authorized service technician.

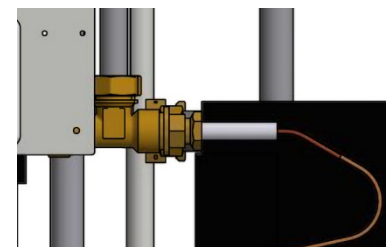

Before starting out repairs, close the shutoff valves **DH supply, DH return, cold-water and hot water**.

Note the setting of the balancing valve, then close it.
Release the pressure using the DHWC safety valve.



After finishing repair; fill up the hot water circuit and vent.
Open the shutoff valves, start with **DH Supply** and then **DH return**, to avoid pollutions in the system. Open the valves slowly to avoid pressure surges.

1. Disconnect the power feed to the substation.
2. Close the shut-off valves.
3. Use a wrench and unscrew the pipe between the pump and T-connection.
4. Remove the old check valve and mount a new.
NOTE! Make sure that the check valve is mounted in the correct way.

Flow direction



5. Mount the pipe again.
6. Open the shutoff valves cold and hot water.
7. Open and adjust the balancing valve.
8. Vent the circuit by opening a hot water tap.
9. Connect the power feed to the substation. Open the shutoff valves DH Supply and then DH return.



Bild 3

17.12 Change the expansion vessel



Maintenance and repairs must be carried out by an authorized service technician.

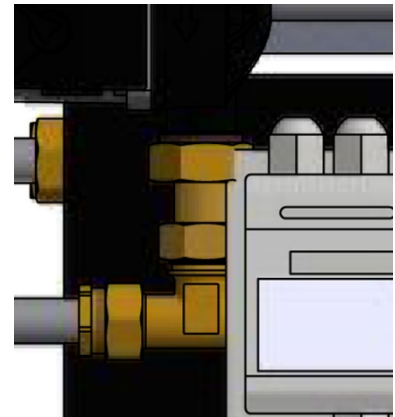

Before starting out repairs, close the shutoff valves **DH supply, DH return, heating supply and heating return**.

Release the pressure using the heating circuit safety valve.



After finishing repair, fill up the circuit and vent.
Then open the shutoff valves, start with **DH supply** and then the **return** line, to avoid pollutions in the system.

Then open **heat return** and then **supply**. Open the valves slowly to avoid pressure surges.

1. Disconnect the power feed to the substation.
2. Close the shut-off valves.
3. Replace the expansion vessel.
4. Fill up the heating circuit using the topping up valve, vent the heating circuit.
5. Open the shutoff valves and connect the power feed to the substation.
6. After final bleeding, the pressure should not be less than 1.0 bar in winter and not less than 0.6 bar in summer.

18 Options

The mounting instructions are described for a new installation. If the kits are supposed to be installed on an already installed subsystem, you must release the water pressure and disconnect the electrical power supply before starting.

18.1 Safety thermostat

Heating systems sensitive to high temperatures for example under-floor heating must be equipped with a safety thermostat. If the heating system is not equipped with the thermostat, the under-floor heating system and floors in general might get damaged.

1. First disconnect the substation electrical power supply cable. Disconnect the electrical plug on the circulation pump.
2. Attach the electrical box for under floor heating on the mounting plate.
3. Connect the new power supply cable from the electrical box to the circulation pump.
4. Reconnect the existing power supply cable to the connection on the electrical box.
5. Attach the thermostat to the pipe for heating supply.
6. Set the correct maximum temperature value for the thermostat.
7. Attach all electrical wires with the necessary number of straps. It is important not to attach electrical wires on primary heating pipes and sharp edges.



Picture 34

18.1.1 Parameters and recommended settings for under floor heating

Set recommended settings for under floor heating systems. Instructions regarding installation parameters see chapter [9 Activation of installer parameters](#).

Parameter	Parameter N:o	Factory Default Setting		Optional Setting	
		Display	Description	Display	Description
Category 1 Parameters - Programmable Thermostat Settings					
OTC heat curve	15:OC	5		1 to 40	1 to 40 adjustment in steps of 1
Category 2 Parameters - System Settings (press PROGRAM to access this category)					
Economy function	3:Pd	0	Diff between outside and calculated water supply temperature	0 to 20	If the calculated water supply temperature is not greater than the outside temperature by this amount the heating will switch off.
Category 3 parameters – Boiler settings (press PROGRAM to access this category)					
Maximum central heating set point	1:CH	45	90°C or obtained from the boiler	40 to 90	40°C to 90°C adjustment in 1°C steps

19 Operating data and performance

19.1 Operating data Mini Plus CB30-60H

	Primary side	DHW
Design pressure PS	16 Bar	10 bar
Design temperature TS	120°C	90°C
Relief pressure safety-valve	-	9/10 Bar
Volume Heat exchanger, L	1,57 L	1,62 L

Temperature program (°C)									
Heating	Capacity kW	CB type	Plates no	Plates primary	Plates secondary	Flow P l/s	dPp kPa	Flow S l/s	dPs kPa
80-25/10-55 (15,5)	113	30	60	1*9H+2*10H	1*10H+2*10H	0,42	24	0,60	46
80-22/10-55 (15,5)	113	30	60	1*9H+2*10H	1*10H+2*10H	0,42	24	0,60	46
70-25/10-58 (20,2)	100	30	60	1*9H+2*10H	1*10H+2*10H	0,48	32	0,50	32
70-25/10-58	128	30	60	1*9H+2*10H	1*10H+2*10H	0,68	61	0,60	45
65-22/10-55	113	30	60	1*9H+2*10H	1*10H+2*10H	0,63	52	0,60	45
65-22/10-55 (19,7)	82	30	60	1*9H+2*10H	1*10H+2*10H	0,43	26	0,43	25

Mini Plus CB30-60H 2017-10-17

19.2 Operating data Mini Plus CB18-54H

	Primary side	Heating
Design pressure PS	16 Bar	6 bar
Design temperature TS	120°C	90°C
Relief pressure safety-valve	-	2,5 Bar
Volume Heat exchanger, L	1,01 L	1,05 L

Temperature program (°C)									
Heating	Capacity kW	CB type	Plates no	Plates primary	Plates secondary	Flow P l/s	dPp kPa	Flow S l/s	dPs kPa
UPML 25-95									
115-65/60-80 (61,48)	60,42	18H	54	1*26 H	1*27 H	0,28	3,0	0,74	20
115-45/40-70 (43,4)	90,1	18H	54	1*26 H	1*27 H	0,32	3,7	0,73	20
115-35/30-35 (30,01)	15	18H	54	1*26 H	1*27 H	0,04	0,1	0,72	20
115-35/30-36 (30,01)	18	18H	54	1*26 H	1*27 H	0,05	0,1	0,72	20
115-35/30-37 (30,02)	21	18H	54	1*26 H	1*27 H	0,06	0,2	0,72	20
100-63/60-80	58,2	18H	54	1*26 H	1*27 H	0,39	5,7	0,71	18,6
100-53/50-70 (52,1)	60,3	18H	54	1*26 H	1*27 H	0,31	3,7	0,73	20
100-48/45-60 (45,68)	45,1	18H	54	1*26 H	1*27 H	0,21	1,7	0,73	20
100-43/40-60 (41,55)	60,1	18H	54	1*26 H	1*27 H	0,26	2,5	0,73	20
100-43/40-70	50	18H	54	1*26 H	1*27 H	0,22	1,9	0,40	6,4
100-43/40-80	20,38	18H	54	1*26 H	1*27 H	0,09	0,3	0,12	0,6
100-33/30-35 (30,01)	15	18H	54	1*26 H	1*27 H	0,05	0,1	0,72	20
100-33/30-36 (30,02)	18	18H	54	1*26 H	1*27 H	0,06	0,2	0,72	20
100-33/30-37 (30,03)	21	18H	54	1*26 H	1*27 H	0,07	0,2	0,72	20
80-55/50-70	43,2	18H	54	1*26 H	1*27 H	0,43	6,9	0,52	10,5
80-63/60-70 (61,65)	30,2	18H	54	1*26 H	1*27 H	0,41	6,3	0,74	20

UPM3 15-70

115-65/60-80 (61,2)	52,53	18H	54	1*26 H	1*27 H	0,25	2,3	0,64	15,3
115-45/40-70 (42,9)	79,42	18H	54	1*26 H	1*27 H	0,28	2,9	0,64	15,6
115-35/30-35 (30,01)	13,3	18H	54	1*26 H	1*27 H	0,04	0,1	0,64	15,9
115-35/30-36 (30,01)	15,96	18H	54	1*26 H	1*27 H	0,05	0,1	0,64	15,9
115-35/30-37 (30,01)	18,62	18H	54	1*26 H	1*27 H	0,06	0,1	0,64	15,9
100-63/60-80 (62,7)	52,53	18H	54	1*26 H	1*27 H	0,35	4,6	0,64	15,3
100-53/50-70 (51,8)	52,73	18H	54	1*26 H	1*27 H	0,27	2,8	0,64	15,4
100-48/45-60 (45,56)	39,62	18H	54	1*26 H	1*27 H	0,18	1,3	0,64	15,5
100-43/40-60 (41,3)	52,94	18H	54	1*26 H	1*27 H	0,23	2	0,64	15,6
100-43/40-70	49,63	18H	54	1*26 H	1*27 H	0,22	1,8	0,40	6,3
100-43/40-80	19,86	18H	54	1*26 H	1*27 H	0,09	0,3	0,12	0,6
100-33/30-35 (30,01)	13,3	18H	54	1*26 H	1*27 H	0,05	0,1	0,64	15,9
100-33/30-36 (30,01)	15,96	18H	54	1*26 H	1*27 H	0,06	0,1	0,64	15,9
100-33/30-37 (30,02)	18,62	18H	54	1*26 H	1*27 H	0,07	0,2	0,64	15,9
80-55/50-70	42,84	18H	54	1*26 H	1*27 H	0,42	6,8	0,52	10,3
80-63/60-70 (61,45)	26,25	18H	54	1*26 H	1*27 H	0,35	4,7	0,64	15,2

Mini Plus CB15-54H 2017-10-17

Cetetherm AB
Fridhemsvägen 15
372 38 Ronneby - Sweden
www.cetetherm.com

Cetetherm
NIBE GROUP MEMBER