



Thinking solutions.

# Expansion vessels



Reflex, Reflex

# Reflex— a powerful brand for decades

Reflex Winkelmann GmbH—part of the Building+ Industry division—is a leading provider of high-quality heating and hot water supply technology systems. Under its Reflex brand, the company, which has its headquarters in Ahlen in the German region of Westphalia, develops, produces and sells not only diaphragm expansion vessels, but also innovative components and holistic solutions for pressure maintenance, water make-up, degassing and water treatment, storage water tanks and plate heat exchangers, as well as hydraulic manifold and tank components. Reflex Winkelmann GmbH has over 2,000 employees worldwide, giving it an international presence in all major markets.

With its energy-efficient and sustainable products, the company is already doing its bit to help the environment, as evidenced by its commitment to sustainability and the climate policy goals agreed by the German Federal Government. This support is built on proven technologies and future-oriented innovations. What's more, Reflex Winkelmann GmbH works together with others as equals, always maintains its focus on the customer and offers additional services such as its own factory service centre fleet and a comprehensive range of training options.







# Contents

<b>Reflex City</b>	p. 4
<b>Pressure maintenance</b>	
Pressure maintenance system tasks	p. 6
<b>Reflex</b>	
Key advantages	p.10
Reflex product portfolio	p.11
Selection and calculation	p.19
Installation and commissioning	p.30
Operation and maintenance	p.34
<b>Refix</b>	
Key advantages	p.35
Refix product portfolio	p.36
Selection and calculation	p.45
Installation and commissioning	p.52
Operation and maintenance	p.53
<b>Services</b>	p.54

## New configuration software



Reflex Solutions Pro  
[rsp.reflex.de/en](https://rsp.reflex.de/en)

→ Read more on [page 54](#)

# Reflex City

SlimLine

Reflex C

Reflex DD

HOTEL





### Reliable pressure maintenance for all requirements

Living, shopping, working and producing: city-life means diversity. Supply technology requirements are as individual as the buildings themselves. Whether it's a 5 kW facility in a detached home or a safety-related cooling system in a computer centre — Reflex offers products and solutions for systems of all sizes and complexities. As shown in our Reflex City concept.

Wherever there is a need for the correct pressure, that's where you will find Reflex pressure maintenance systems. As the market leader, Reflex services many different application areas: from solar systems in homes, via direct installation in boilers, to drinking water supplies in residential complexes.

# Pressure maintenance

## Pressure maintenance system tasks

Correct pressure ratios are a basic precondition for correct functioning of heating, solar and cooling water systems and pressure booster systems. Like all other substances, the volume of water changes with its temperature. Unlike other liquids, water does not expand proportionately to the temperature. As water cannot be compressed, this means the pressure increases significantly in closed systems as the temperature changes.

Optimum pressure maintenance is achieved with two different pressure maintenance systems depending on the application:

- Static pressure maintenance systems (expansion vessels)
- Dynamic pressure maintenance systems

 Further information can be found in the brochure: [Pressurisation Systems](#)

Essentially, pressure maintenance systems have to fulfil three fundamental tasks:

1. Maintain the pressure within permissible limits at all points in the facility system. This means ensuring the permissible operating pressure is not exceeded but also maintaining a minimum pressure to avoid negative pressures, cavitation and evaporation.
2. Compensating fluctuations in the volume of the facility water as a result of fluctuations in temperature.
3. Balancing systemic water losses using a water reservoir.

### Water uptake volume of a pressure expansion vessel

Pressure maintenance is required to compensate fluctuations in volume between the maximum and the minimum system temperature and thus to maintain the pressure within a permissible range. To achieve this, there must be a sufficient water uptake volume which must correspond to the expansion volume  $V_e$  and the water reservoir  $V_V$ . If devices are installed which extract and feed back a volume of water  $V_D$  from the system during operation, such as a vacuum degasser, this must also be taken into consideration. This also applies to volumes of steam  $V_S$  which occur during downtimes in solar collectors. If the temperature of the medium drops below  $0^\circ\text{C}$  or exceeds  $70^\circ\text{C}$  at the connection point of the pressure maintenance in the facility system, an auxiliary vessel is to be installed in order to protect the bladder of the expansion vessel.

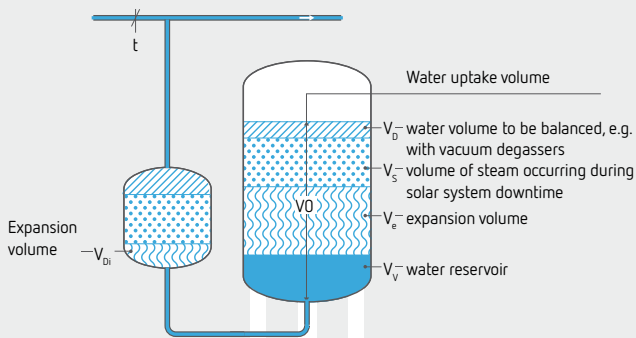

- in heating systems proportion of  $V_e$  for  $t > 70^\circ\text{C}$
- in cooling systems proportion of  $V_e$  for  $t < 0^\circ\text{C}$

### Expansion volume flow and point of zero pressure

A balancing volume flow must be transported via the expansion line between the system and pressure maintenance such that the calculated pressures for the pressure maintenance are produced correctly at the point of zero pressure.

In closed heating, solar and cooling systems, it is assumed that the expansion volume flow  $\dot{V}_e$  is the largest possible balancing volume flow. It occurs when the thermal output  $\dot{Q}_G$  of heating or cooling sources is switched on or off.

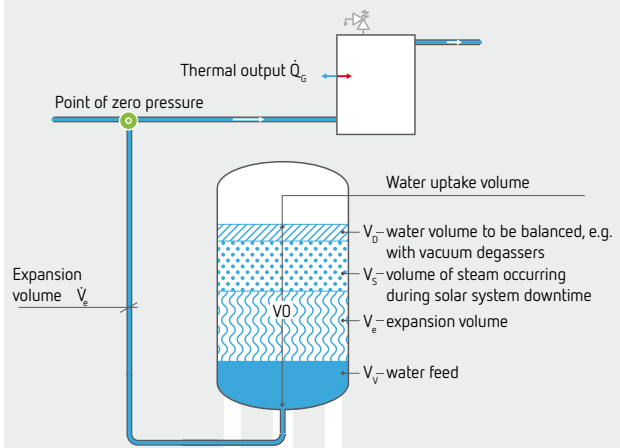



## Static pressure maintenance systems

**Expansion vessels** work as expansion or buffer vessels without electricity, a compressor or pump. Expansion vessels have to balance the volume fluctuations between the greatest and the lowest temperature. Product in the Reflex portfolio are used as expansion vessels in heating, solar and cooling water systems and products in the Reflex portfolio are used to save potable water in hot water heating systems.

**Buffer and control vessels** have to provide an intermediate storage for the difference between the requested and the required volume flow. If the requirement is to reduce the switching frequency of the feed device, this is also known as a control vessel. In principle, the Reflex product range is used as a buffer vessel in a pressure booster system while the Reflex range is used as a control vessel in pump-driven pressure maintenance stations.

**Reflex** for closed heating, solar and cooling water systems



**Reflex** for potable and process water systems as well as special applications

## Installation and function

**Reflex** in a heating system (example)

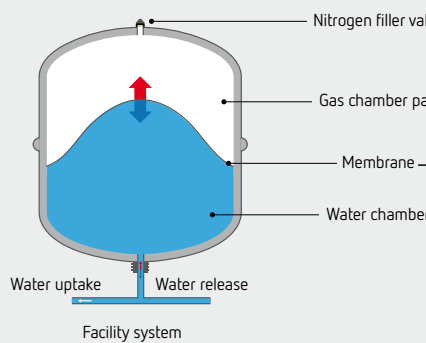

**Reflex** in a pressure booster system (example)

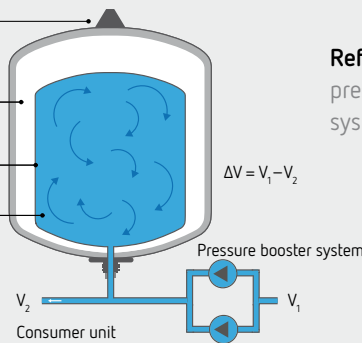

The pressure pad supports the water column in the system and is adjusted accordingly before the vessel is filled with a volume of water. As the system is heated, the pressure increases resulting in the expanding water flowing from the facility system to the water chamber. The pressure pad in the gas chamber is compressed and the pressure increases. As the system cools, the volume decreases and the pressure drops: the expansion water flows out of the water chamber back into the facility system. The pressure pad in the gas chamber is adjusted to just under the cut-in pressure of the feed

device. When the pressure drops below the cut-in pressure, the pump switches on and feeds the water. If the consumer units remove a lesser amount, the difference is temporarily stored in the buffer tank until the pressure pad is compressed to the cut-out pressure and the pressure booster system switches off. The resulting pressure drop leads to a reduction in volume. If the consumer units draw water, temporarily stored water is extracted from the buffer tank until the the cut-in pressure occurs at the pressure pad and the pressure booster system is switched on again.

# Expansion vessels

For heating, solar and cold water systems

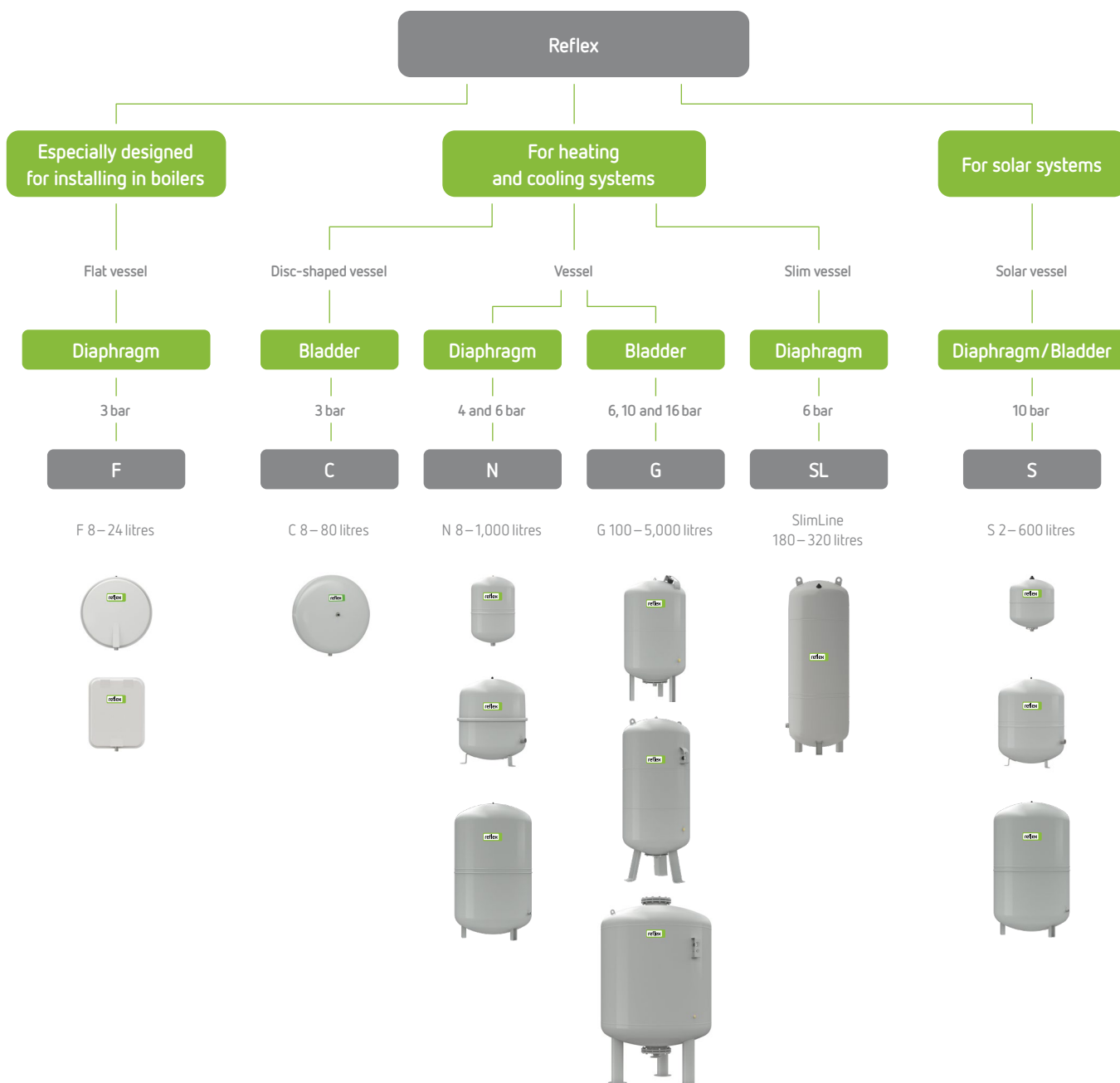

V Auxiliary vessels

Without membrane

V 6 – V 350 → 10 bar/110 °C  
 V 500 – 5,000 litres → 6 bar/120 °C  
 V 500 – 5,000 litres → 10 bar/120 °C





Other pressure ratings available on request



## For drinking and non-drinking systems

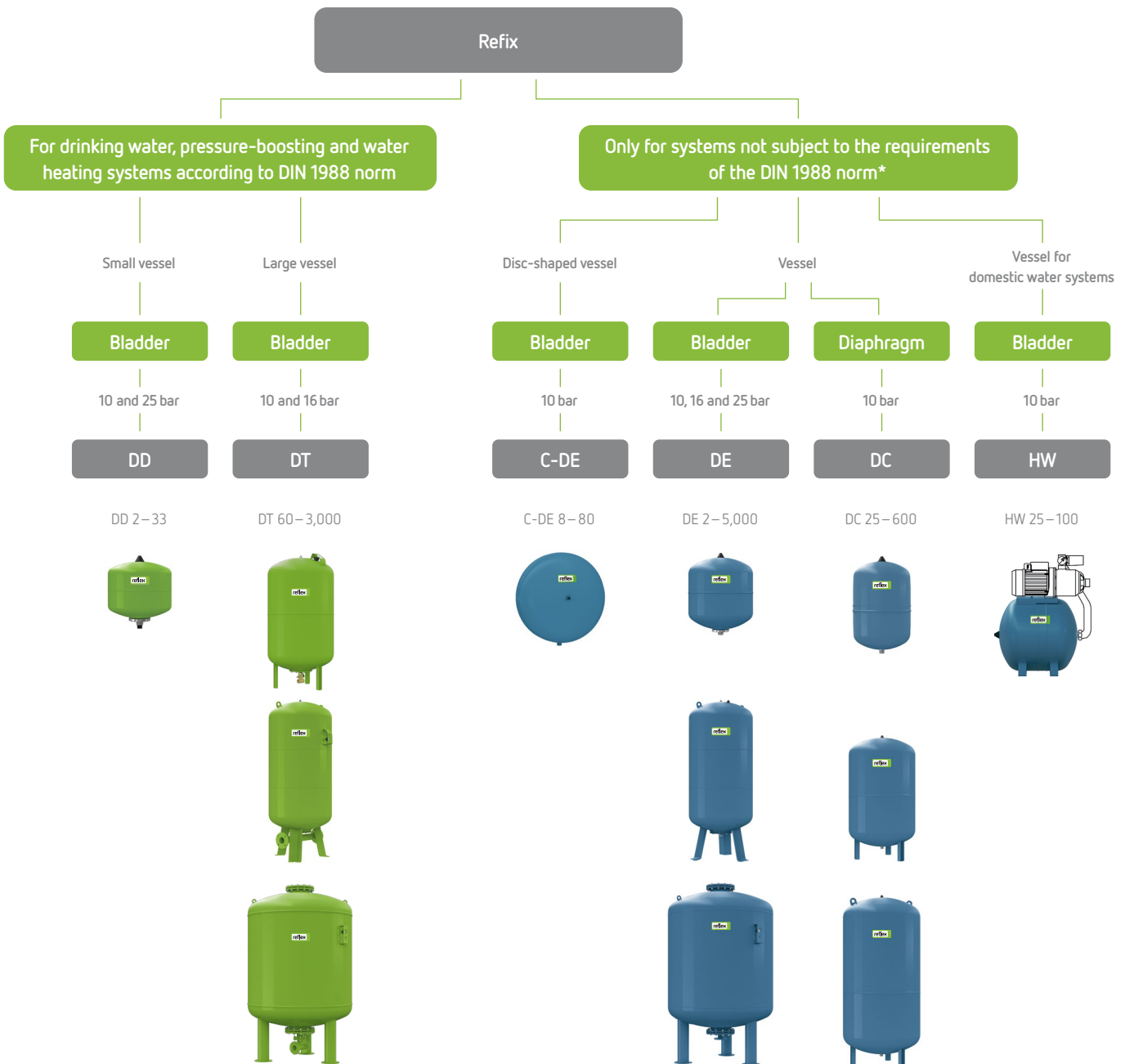

Water shock arrester

Diaphragm

WD\*\*



0.165 litres/10 bar\*\*

For example, installation directly at the draw-off point

\* For example, fire extinguishing and non-drinking water systems, underfloor heating, geothermal energy.

\*\* Not approved for drinking water.

## Key advantages

### High-quality expansion vessels

- For closed heating and cooling water systems as well as solar applications and process water
- Long-lasting, wear-resistant membrane reliably maintains the pressure
- Approved in accordance with pressure equipment guidelines 2014/68/EU

### Wide range of designs

- Extremely broad pressure ranges and vessel volumes
- Extremely wide range of forms, types and comprehensive range of accessories
- With diaphragm or bladder
- Many years of experience with special, customer-specific solutions

### Rapid design and installation

- Intuitive design configuration software for rapid selection and calculation
- Rapid installation





# Reflex product portfolio

## Reflex N

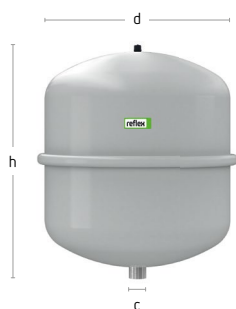

N 8 – 251

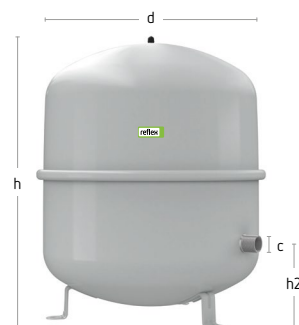

N 35 – 1401

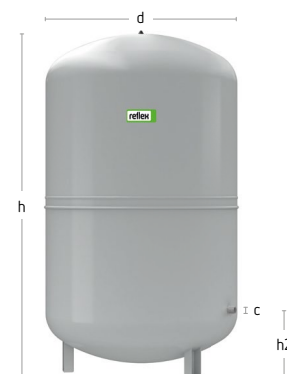

N 200 – 1,0001

### Technical Features

- For closed heating and cooling systems
- With threaded connections
- 35 litres and above upright, size N 80 and below wall mounting
- Non-replaceable diaphragm according to DIN EN 13831
- Max. operating temperature 70 °C
- For antifreeze additive of at least 25–50 %
- Approval according to Pressure Equipment Directive 2014/68/EU
- Durable epoxy resin coating
- With factory-pressurised gas chamber
- Max. permissible system temperature 120 °C

	Type	Art. No.		DG	PQ [pce]	Inlet pressure [bar]	Connection c	Ø d [mm]	Height h [mm]	Height h2 [mm]	Weight [kg]
		grey	white								
4 bar 70 °C	N 8	8202501	7202801	0012	84	1.5	R ¾"	272	236	–	2.35
	N 12	8203301	7203501	0012	60	1.5	R ¾"	272	317	–	2.75
	N 18	8204301	7204401	0012	60	1.5	R ¾"	308	360	–	3.60
	N 25	8206301	7206401	0012	48	1.5	R ¾"	308	477	–	4.35
	N 35	8208401	7208501	0012	24	1.5	R ¾"	376	466	130	5.60
6 bar 70 °C	N 50	8209300	7209400	0013	24	1.5	R ¾"	441	487	175	9.60
	N 80	8210200	7210600	0013	12	1.5	R 1"	512	558	172	13.28
	N 100	8216300	–	0013	10	1.5	R 1"	512	669	172	15.84
	N 140	8211400	–	0013	6	1.5	R 1"	512	890	172	19.90
	N 200	8213300	–	0018	4	1.5	R 1"	634	758	205	23.80
	N 250	8214300	–	0018	4	1.5	R 1"	634	888	205	24.70
	N 300	8215300	–	0018	1	1.5	R 1"	634	1,092	235	30.00
	N 400	8218000	–	0018	1	1.5	R 1"	740	1,102	245	47.00
	N 500	8218300	–	0018	1	1.5	R 1"	740	1,321	245	52.00
	N 600	8218400	–	0018	1	1.5	R 1"	740	1,531	245	66.00
	N 800	8218500	–	0018	1	1.5	R 1"	740	1,996	245	96.00
	N 1000	8218600	–	0018	1	1.5	R 1"	740	2,413	245	118.00

## Reflex C

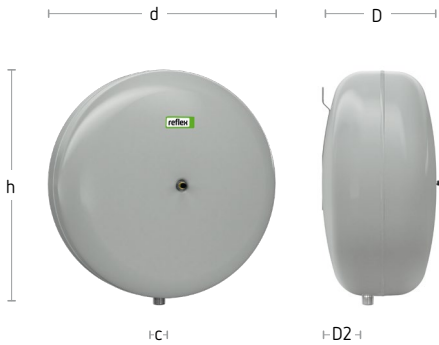

C 8 – 80l

### Technical Features

- For closed heating and cooling systems
- With threaded connections
- Including brackets for easy installation
- Non-replaceable bladder according to DIN EN 13831
- Max. operating temperature 70 °C
- For antifreeze additive of at least 25 – 50 %
- Approval according to Pressure Equipment Directive 2014/68/EU
- Durable epoxy resin coating
- With factory-pressurised gas chamber
- Max. permissible system temperature 120 °C

	Type	Art. No.	DG	PQ	Inlet pressure	Connection c	Ø d	Height h	Depth D	Depth D2	Weight
		grey		[pce]	[bar]		[mm]	[mm]	[mm]	[mm]	[kg]
3 bar 70 °C	C 8	8280000	0017	96	1.0	G ½"	280	296	176	52	2.71
	C 12	8280100	0017	60	1.0	G ½"	354	370	182	64	3.60
	C 18	8280200	0017	42	1.0	G ¾"	356	370	236	76	4.10
	C 25	8280300	0017	42	1.0	G ¾"	409	427	253	93	5.10
	C 35	8280400	0017	24	1.0	G ¾"	480	465	256	97	6.55
	C 50	8280500	0017	20	1.5	G ¾"	480	465	332	125	8.00
	C 80	8280600	0017	8	1.5	G ¾"	634	621	338	135	15.70

## Reflex F

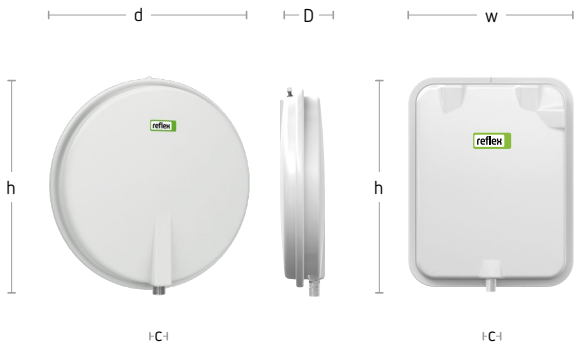

F 8l

F 12 – 24l

### Technical Features

- Flat vessel for closed heating and cooling systems, especially for installation in boilers
- With threaded connections
- 18 litres and above with fixing strap
- Non-replaceable diaphragm according to DIN EN 13831
- Max. operating temperature 70 °C
- For antifreeze additive of at least 25 – 50 %
- Approval according to Pressure Equipment Directive 2014/68/EU
- Durable epoxy resin coating
- With factory-pressurised gas chamber
- Max. permissible system temperature 120 °C
- Reflex F 8 vessel recognised with the Plus X-Award

	Type	Art. No.	DG	PQ	Inlet pressure	Connection c	Ø d	Height h	Width w	Depth D	Depth D2	Weight
		white		[pce]	[bar]		[mm]	[mm]	[mm]	[mm]	[mm]	[kg]
3 bar 70 °C	F 8	2407000	0015	54	0.75	G ¾"	389	389	350	88	72	4.15
	F 12	2211900	0015	36	1.00	G ½"	–	444	350	108	81	6.60
	F 15	2215500	0015	36	1.00	G ¾"	–	444	350	134	97	7.12
	F 18	2218300	0015	28	1.00	G ¾"	–	444	350	158	109	7.70
	F 24	2219000	0015	25	1.00	G ¾"	–	444	350	180	120	9.10



## Reflex SL

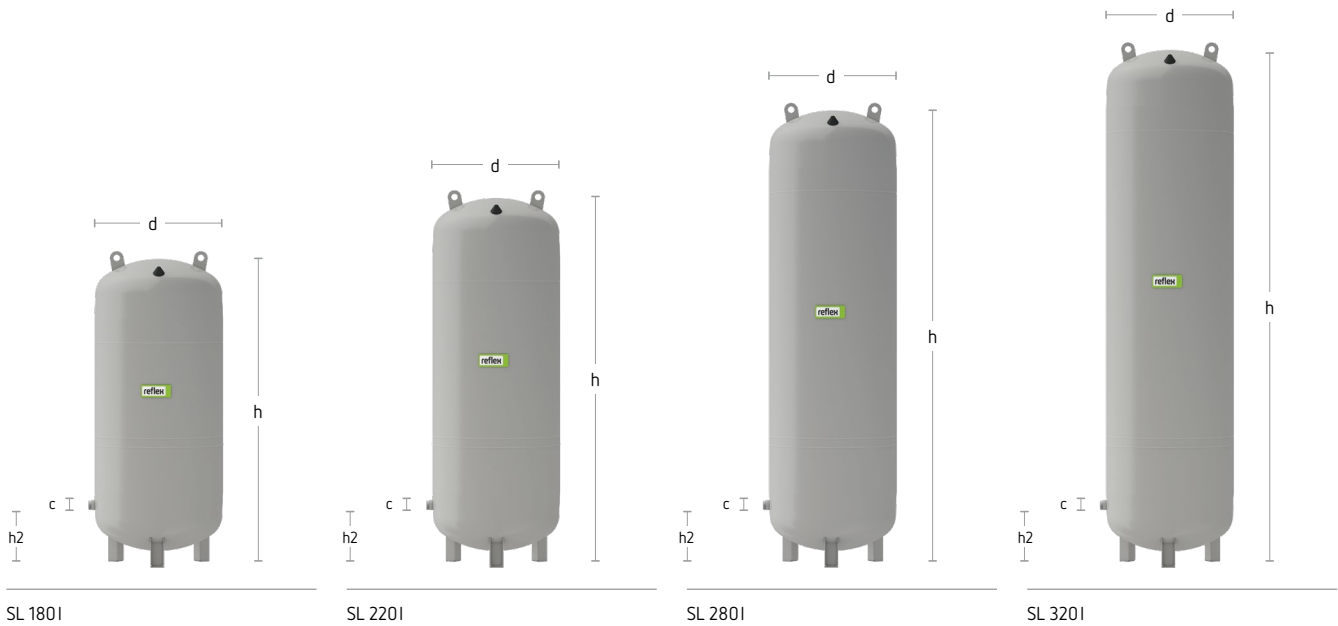

The footprint of the Reflex SlimLine vessels correspond to the footprint and the usable volume of the OTTO Expansomat: direct exchange is therefore possible.



### Technical Features

- The footprint of Reflex SlimLine vessels corresponds to the footprint and usable capacity of the OTTO Expansomat, making a direct exchange possible
- Slim, space-saving vessel For closed heating and cooling systems
- Non-replaceable diaphragm according to DIN EN 13831
- With factory-pressurised gas chamber
- Durable epoxy resin coating
- With threaded connections
- For antifreeze additive of at least 25–50 %
- Max. operating pressure 6 bar
- Max. operating temperature 70 °C
- Max. permissible system temperature 120 °C

	Type	Art. No.	DG	PQ	Inlet pressure	Connection	Ø d	Height h	Height h2	Weight
		grey		[pce]	[bar]	c	[mm]	[mm]	[mm]	[kg]
6 bar 70 °C	SL 180	8200200	0020	1	1.5	G1"	480	1,156	214	27.38
	SL 220	8200250	0020	1	1.5	G1"	480	1,386	214	33.34
	SL 280	8200300	0020	1	1.5	G1"	480	1,716	214	41.82
	SL 320	8200350	0020	1	1.5	G1"	480	1,946	214	47.78

## Reflex G

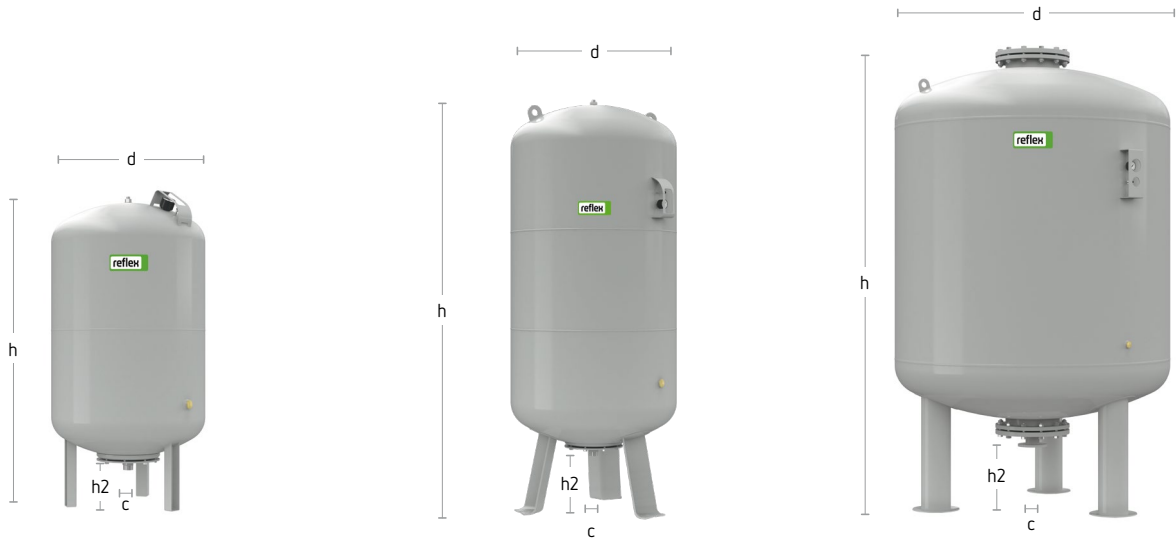

G 100–500 l

G 600–1,000 l

G 1,000–5,000 l

### Technical Features

- For closed heating and cooling systems
- Upright configuration
- Connections:
  - up to 1,000 l /  $\varnothing$  740 mm with threaded connections
  - From 1,000 l /  $\varnothing$  1,000 mm with flange connections DN65/PN6 or DN65/PN16
- Replaceable bladder according to DIN EN 13831
- Max. operating temperature 70 °C
- For antifreeze additive of at least 25–50 %
- Approval according to Pressure Equipment Directive 2014/68/EU
- The following types are equipped with a diaphragm break detector coupling:
  - 6 bar:  $\geq$  1,000 l /  $\varnothing$  1,000 mm
  - 10 bar:  $\geq$  600 l
  - 16 bar
- With inspection opening (from 1,000 litres with  $\varnothing$  1,000 mm)
- Pressure gauge and supply pressure valve protected by clip
- Durable epoxy resin coating
- With factory-pressurised gas chamber
- Max. permissible system temperature 120 °C

	Type	Art. No. grey	DG	PQ [pce]	Inlet pressure [bar]	Connection c	Ø d [mm]	Height h [mm]	Height h2 [mm]	Weight [kg]
6 bar 70 °C	G 100	8519000	0021	4	3.5	G1"	480	850	145	19.20
	G 200	8519100	0021	1	3.5	G 1 ¼"	634	967	144	36.50
	G 300	8519200	0021	1	3.5	G 1 ¼"	634	1,267	144	41.60
	G 400	8521605	0021	1	3.5	G1"	740	1,276	146	43.00
	G 500	8521705	0021	1	3.5	G1"	740	1,494	146	51.00
	G 600	8522605	0021	1	3.5	G1"	740	1,739	146	66.00
	G 800	8523610	0021	1	3.5	G1"	740	2,186	149	94.00
	G 1000/740	8546605	0021	1	3.5	G1"	740	2,593	146	150.00
	G 1000/1000	8524605	0022	1	3.5	DN65/PN6	1,000	1,973	307	228.00
	G 1500	8526605	0022	1	3.5	DN65/PN6	1,200	1,971	305	280.00
	G 2000	8527605	0022	1	3.5	DN65/PN6	1,200	2,451	291	300.00
	G 3000	8544605	0022	1	3.5	DN65/PN6	1,500	2,490	334	620.00
	G 4000	8529605	0022	1	3.5	DN65/PN6	1,500	3,065	334	770.00
G 5000	8530605	0022	1	3.5	DN65/PN6	1,500	3,598	334	849.00	
10 bar 70 °C	G 100	8518000	0021	4	3.5	G1"	480	850	146	19.20
	G 200	8518100	0021	1	3.5	G 1 ¼"	634	966	144	33.40
	G 300	8518200	0021	1	3.5	G 1 ¼"	634	1,267	144	34.60
	G 400	8521005	0021	1	3.5	G 1 ¼"	740	1,275	133	52.00
	G 500	8521006	0021	1	3.5	G 1 ¼"	740	1,494	133	60.00
	G 600	8522006	0021	1	3.5	G 1 ½"	740	1,859	263	118.00
	G 800	8523005	0021	1	3.5	G 1 ½"	740	2,324	263	166.00
	G 1000/740	8546005	0021	1	3.5	G 1 ½"	740	2,804	263	190.00
	G 1000/1000	8524005	0022	1	3.5	DN65/PN16	1,000	2,001	286	335.00
	G 1500	8526005	0022	1	3.5	DN65/PN16	1,200	1,991	291	390.00
	G 2000	8527005	0022	1	3.5	DN65/PN16	1,200	2,451	291	485.00
	G 3000	8544005	0022	1	3.5	DN65/PN16	1,500	2,542	320	830.00
	G 4000	8529005	0022	1	3.5	DN65/PN16	1,500	3,117	320	1,120.00
G 5000	8530005	0022	1	3.5	DN65/PN16	1,500	3,652	320	1,274.00	
16 bar 70 °C	G 100	8518400	0021	1	3.5	DN25/PN16	480	992	231	25.00
	G 200	8518500	0021	1	3.5	DN25/PN16	634	1,088	221	57.00
	G 300	8518600	0021	1	3.5	DN25/PN16	634	1,392	221	66.00
	G 400	8510206	0021	1	3.5	DN40/PN16	740	1,373	198	118.00
	G 500	8518700	0021	1	3.5	DN40/PN16	740	1,618	197	130.00
	G 600	8522007	0021	1	3.5	DN40/PN16	740	1,871	198	158.00
	G 800	8523906	0021	1	3.5	DN40/PN16	740	2,336	198	221.00
	G 1000/740	8546906	0021	1	3.5	DN40/PN16	740	2,804	201	260.00
	G 1000/1000	8524205	0022	1	3.5	DN65/PN16	1,000	2,031	276	468.00
	G 1500	8526305	0022	1	3.5	DN65/PN16	1,200	2,021	281	650.00
	G 2000	8527100	0022	1	3.5	DN65/PN16	1,200	2,481	281	731.00
	G 3000	8544705	0022	1	3.5	DN65/PN16	1,500	2,550	310	960.00
	G 4000	8529405	0022	1	3.5	DN65/PN16	1,500	3,110	310	890.00
G 5000	8529705	0022	1	3.5	DN65/PN16	1,500	3,645	310	1,020.00	



# Reflex S

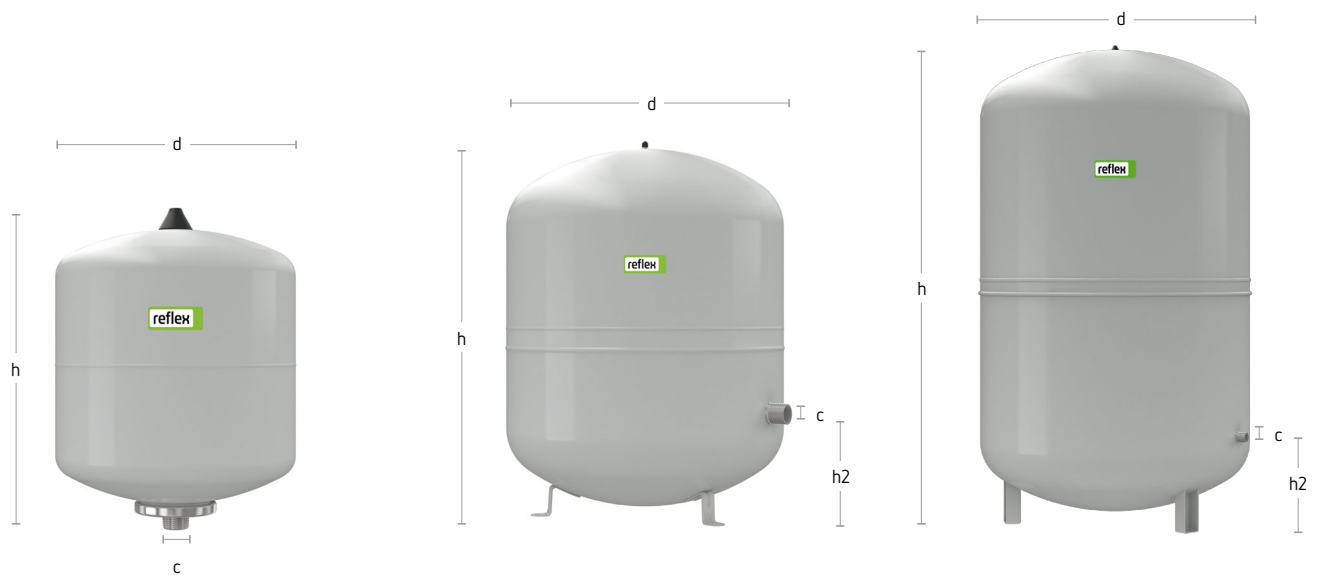

S 2–33 l

S 50–250 l

S 300–600 l

Technical Features

- For solar, heating and cooling systems
- With threaded connections
- 33 litres with brackets, from 50 litres with adjustable feet
- For antifreeze additive of at least 25–50 %
- Up to 33 litres non-replaceable bladder, non-replaceable diaphragm for 50–600 litres
- Max. operating temperature 70 °C
- Approval according to Pressure Equipment Directive 2014/68/EU
- Durable epoxy resin coating
- With factory-pressurised gas chamber
- Max. permissible system temperature 120 °C

	Type	Art. No.		DG	PQ [pce]	Inlet pressure [bar]	Connection c	Ø d [mm]	Height h [mm]	Height h2 [mm]	Weight [kg]
		grey	white								
10 bar 70 °C	S 2	8707700	–	0014	280	0.5	G ¾"	132	260	–	0.98
	S 8	8703900	9702600	0014	96	1.5	G ¾"	206	332	–	1.80
	S 12	8704000	9702700	0014	60	1.5	G ¾"	280	300	–	2.16
	S 18	8704100	9702800	0014	56	1.5	G ¾"	280	409	–	2.95
	S 25	8704200	9702900	0014	42	1.5	G ¾"	280	518	–	3.68
	S 33	8706200	9706300	0014	24	1.5	G ¾"	354	455	–	4.80
	S 50	8209500	–	0019	20	3.0	R ¾"	415	469	158	8.06
	S 80	8210300	–	0019	12	3.0	R 1"	486	562	166	12.10
	S 100	8210500	–	0019	10	3.0	R 1"	486	667	165	12.90
	S 140	8211500	–	0019	6	3.0	R 1"	486	886	172	19.05
	S 200	8213400	–	0019	1	3.0	R 1"	640	758	205	27.50
	S 250	8214400	–	0019	1	3.0	R 1"	640	888	205	32.40
	S 300	8215400	–	0019	1	3.0	R 1"	640	1,092	235	47.00
	S 400	8219000	–	0019	1	3.0	R 1"	746	1,102	245	61.00
	S 500	8219100	–	0019	1	3.0	R 1"	746	1,321	245	72.00
S 600	8219200	–	0019	1	3.0	R 1"	746	1,559	245	87.00	

# Reflex V

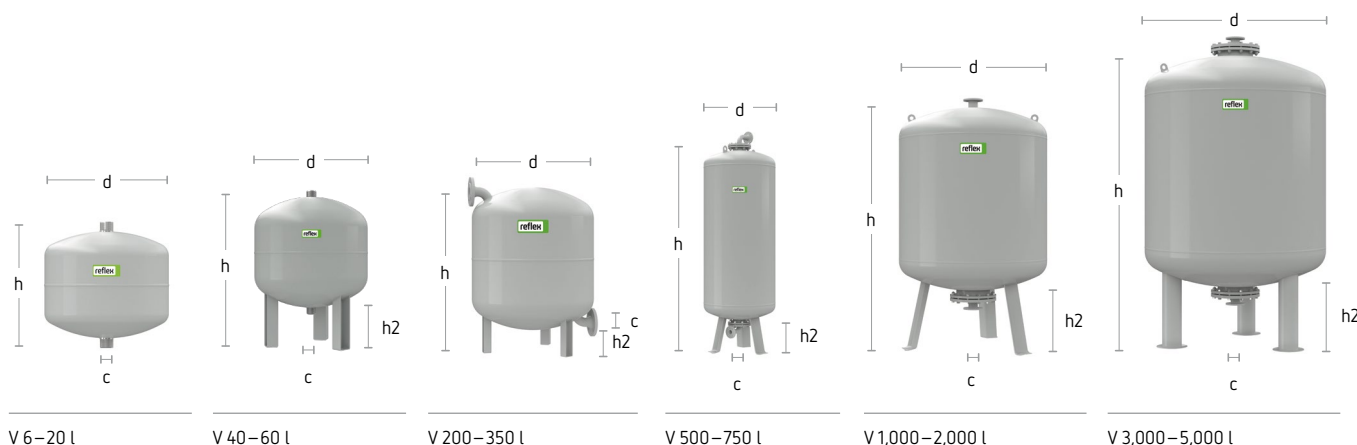

V 6–20 l

V 40–60 l

V 200–350 l

V 500–750 l

V 1,000–2,000 l

V 3,000–5,000 l

## Technical Features

- Auxiliary vessel Without membrane
- Approval according to Pressure Equipment Directive 2014/68/EU
- From V 40 with feet
- Required for systems with return temperatures greater than the maximum permissible operating temperature of the diaphragm expansion vessel or in cooling systems with temperatures less than the maximum permissible operating temperature of the diaphragm expansion vessel
- Can also be used as a buffer storage tank
- Special vessel >10 bar / >120 °C available upon request
- Durable epoxy resin coating

	Type	Art. No.	DG	PQ	Connection	Ø	Height	Height	Weight
		grey		[pce]	c	d	h	h2	
						[mm]	[mm]	[mm]	[kg]
6 bar 120 °C	V 500	8852800	0024	1	DN40/PN6	750	1,717	208	160.00
	V 750	8851800	0024	1	DN40/PN6	750	2,323	208	205.00
	V 1000	8851905	0024	1	DN65/PN6	1,000	2,020	305	310.00
	V 1500	8852305	0024	1	DN65/PN6	1,200	2,020	305	405.10
	V 2000	8852405	0024	1	DN65/PN6	1,200	2,478	305	545.00
	V 3000	8852505	0024	1	DN65/PN6	1,500	2,556	337	775.00
	V 4000	8853405	0024	1	DN65/PN6	1,500	3,131	337	1,060.00
	V 5000	8854805	0024	1	DN65/PN6	1,500	3,666	337	1,095.00
	10 bar 110 °C	V 6	8303100	0024	96	R ¾"	206	244	–
V 12		8303200	0024	72	R ¾"	280	244	–	3.30
V 20		8303300	0024	42	R ¾"	280	360	–	3.30
V 40		8303400	0024	18	R 1"	409	562	113	9.75
V 60		8303500	0024	12	R 1"	409	732	172	12.40
V 200		8303600	0024	1	DN40/PN16	634	901	142	35.25
V 300		8303700	0024	1	DN40/PN16	634	1,201	142	48.00
V 350		8303800	0024	1	DN40/PN16	634	1,341	142	51.00
10 bar 120 °C	V 500	8400105	0024	1	DN40/PN16	750	1,644	208	290.00
	V 750	8400155	0024	1	DN40/PN16	750	2,258	197	420.00
	V 1000	8400205	0024	1	DN65/PN16	1,000	2,055	286	560.00
	V 1500	8400305	0024	1	DN65/PN16	1,200	2,045	284	636.10
	V 2000	8400405	0024	1	DN65/PN16	1,200	2,505	284	940.00
	V 3000	8400505	0024	1	DN65/PN16	1,500	2,600	313	1,405.00
	V 4000	8400605	0024	1	DN65/PN16	1,500	3,178	313	1,930.00
V 5000	8400705	0024	1	DN65/PN16	1,500	3,713	313	2,015.00	

## Reflex accessories

### Safe shut-offs

According to DIN EN 12828

"the water chamber in expansion vessels must be ... able to be emptied. All expansion vessels are to be designed such that they can be shut-off from the heating system."

We recommend the following for standard systems:

- use same size Reflex cap valve as the expansion vessel for expansion vessel with R ¾ threaded connections and R 1
- for expansion vessel with flange connections the same size as the expansion line (see page 21 for range)

### Cap valve

- Secured shut-off for maintenance and dismantling of expansion vessels
- With drainage
- According to DIN EN 12828
- 10 bar/120 °C



### AG connection set

- For rapid assembly and maintenance of membrane expansion vessels
- Incl. secured shut-off and connecting bend with screw connection
- With drainage cock (G ½") and hose nozzle
- According to DIN EN 12828
- 10 bar/100 °C

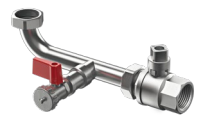

### Wall-hung holders

#### Wall-hung console with multi-connections

- Wall-hung console with multiconnections for Reflex 8–25 litres
- With vessel connection at the top



#### Wall mounting bracket with clamping strap

- Console with clamping strap for Reflex 6–25 litres
- Upright assembly



### Bladder rupture detector

- Indication of membrane rupture in vessels
- Consisting of an electrode relay and an electrode (factory fitted)
- Power supply 230 V/50 Hz
- Floating output (changeover contact)
- Delivery only in combination with a vessel with MBM coupling



### Digital pressure gauge

DIN EN 12828: "Expansion vessels are to be maintained on an annual basis. The inlet gas pressure  $p_0$  is to be checked with a fitting while waterless and corrected if necessary."

- Inlet pressure tester up to about 9 bar



Type	Art. No.	Weight [kg]
AG connection set AG 1"	9119204	0.85
AG connection set AG 1 ¼"	9119205	1.00
AG connection set AG 1 ½"	9119206	1.15
Digital pressure gauge	9119198	0.06
Bladder rupture detector MBM II	7857700	0.62
Cap valve SU R ¾" x ¾"	7613000	0.26
Cap valve SU R 1" x 1"	7613100	0.57
Wall mounting bracket with clamping strap	7611000	0.22
Wall-hung console with multi-connections	7612000	0.90

# Selection and calculation

## Pressures in the system

Valid for supply pressure maintenance in heating, cooling and solar thermal systems

### Excess pressures

- $p_{st}$  = static pressure
- $p_0$  = minimum operating pressure
- $p_a$  = supply pressure
- $p_e$  = final pressure
- $p_{sv}$  = safety valve actuating pressure

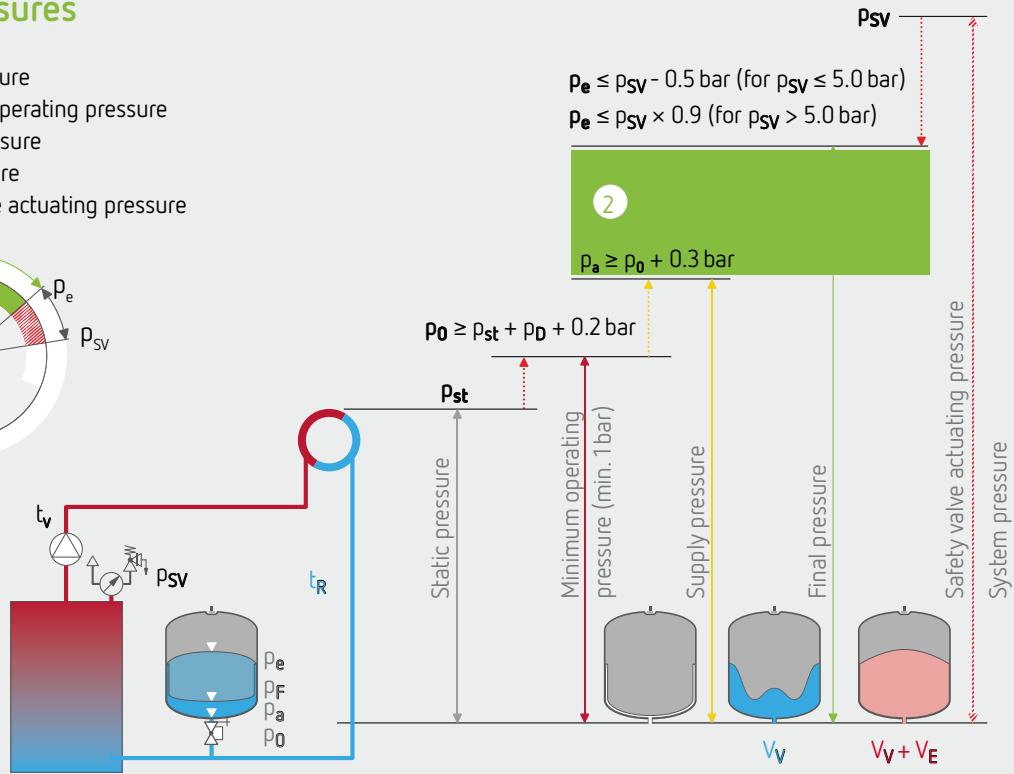
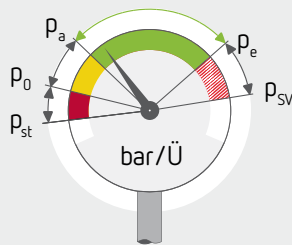

### Calculation values

Pressures are given as excess pressures and relate to the connecting pieces for the expansion vessel up to the highest point in the system.

### Reflex recommendations

- Set the safety valve operating pressure sufficiently high:  
 $p_{sv} \geq p_0 + 1.5 \text{ bar}$
- If possible, when calculating the inlet gas pressure, select an extra 0.2 bar:  
 $p_0 \geq \frac{H[m]}{10} + 0.2 \text{ bar}$
- Select an supply pressure of at least 1 bar on account of the necessary supply pressure for the flow-through pumps—even for rooftop infrastructure centres:  $p_0 \geq 1 \text{ bar}$
- Set the fill or supply pressure on the water side in vented systems in cold condition at least 0.3 bar above the supply pressure to ensure a water reservoir in the expansion vessel ( $V_v = 0.005 \times V_A$  **at least 3 l** for  $V_n > 15 \text{ l}$  minimum volume indication according to the standard):  $p_f \geq p_0 + 0.3 \text{ bar}$



## Quick selection table for expansion vessels

Heating systems: 70/50°C		Marker shows selection for Reflex S — other table: Selection for Reflex N													
Safety valve p <sub>sv</sub>	bar	2.5			V <sub>n</sub>	3.0				V <sub>n</sub>	4.0				V <sub>n</sub>
Inlet pressure p <sub>0</sub>	bar	0.5	1.0	1.5	litres	0.5	1.0	1.5	1.8	litres	1.5	2.0	2.5	3.0	litres
Contents V <sub>A</sub>	litres														
		107	48	–	8	133	82	31	–	8	87	48	8	–	8
		161	71	–	12	199	122	46	–	12	131	71	12	–	12
		268	134	–	18	325	210	96	27	18	223	134	45	–	18
		424	238	52	25	504	344	185	89	25	362	238	114	–	25
		639	387	126	35	730	536	313	179	35	561	387	213	–	35
		912	608	238	50	1,043	782	504	313	50	811	608	362	114	50
		1,460	973	461	80	1,668	1,251	834	580	80	1,298	973	649	263	80
		1,825	1,217	608	100	2,086	1,564	1,043	730	100	1,622	1,217	811	362	100
		2,555	1,703	852	140	2,920	2,190	1,460	1,022	140	2,271	1,703	1,135	561	140
		3,650	2,433	1,217	200	4,171	3,128	2,086	1,460	200	3,244	2,433	1,622	811	200
		4,562	3,041	1,521	250	5,214	3,910	2,607	1,825	250	4,055	3,041	2,028	1,014	250
		5,474	3,650	1,825	300	6,257	4,692	3,128	2,190	300	4,866	3,650	2,433	1,217	300
		7,299	4,866	2,433	400	8,342	6,257	4,171	2,920	400	6,488	4,866	3,244	1,622	400
		9,124	6,083	3,041	500	10,428	7,821	5,214	3,650	500	8,110	6,083	4,055	2,028	500
		10,949	7,299	3,650	600	12,513	9,385	6,257	4,380	600	9,732	7,299	4,866	2,433	600
		14,599	9,732	4,866	800	16,684	12,513	8,342	5,839	800	12,976	9,732	6,488	3,244	800
		18,248	12,165	6,083	1,000	20,855	15,641	10,428	7,299	1,000	16,221	12,165	8,110	4,055	1,000

Customised planning with the Reflex Pro calculation program



Reflex Solutions Pro  
[rsp.reflex.de/en](http://rsp.reflex.de/en)

## Example calculation

Water content (approximately)

**Radiators:**

$$V_A = \dot{Q} \text{ [kW]} \times 13.51 / \text{kW}$$

**Panel radiators:**

$$V_A = \dot{Q} \text{ [kW]} \times 8.51 / \text{kW}$$

Selection example

$$\begin{aligned} p_{sv} &= 3 \text{ bar} \\ H &= 13 \text{ m} \\ \dot{Q} &= 40 \text{ kW (70/50 °C panel)} \\ V_{PH} &= 1,000 \text{ l} \\ &\quad \text{(V buffer storage tank)} \end{aligned}$$

**Calculation:**

$$V_A = 40 \text{ kW} \times 8.51 / \text{kW} + 1,000 = 1,340 \text{ l}$$

$$p_0 \geq \left( \frac{13}{10} + 0.2 \text{ bar} \right) = 1.5 \text{ bar}$$

From the table

$$\begin{aligned} \text{with } p_{sv} &= 3 \text{ bar and} \\ p_0 &= 1.5 \text{ bar} \\ V_A &= 1,340 \text{ l} \\ \rightarrow V_n &= 140 \text{ l} \\ &\quad \text{(for } V_A \text{ max. 1,460 l)} \end{aligned}$$

**Selected:**

- 1 x Reflex N 140, 6 bar, → page 11
- 1 x cap ball valve, → page 18

Heating systems: 70/50°C		Marker shows selection for Reflex S — other table: Selection for Reflex N											
Safety valve $p_{SV}$	bar	5.0					$V_n$	6.0					
Inlet pressure $p_0$	bar	2.0	2.5	3.0	3.5	4.0	litres	2.0	2.5	3.0	3.5	4.0	5.0
Contents $V_A$	litres	91	58	26	–	–	8	118	90	63	35	7	–
		136	88	39	–	–	12	177	136	94	52	10	–
		231	158	85	12	–	18	293	230	167	105	42	–
		373	272	170	69	–	25	459	372	285	197	110	–
		576	434	292	150	8	33	679	574	452	330	208	–
		829	664	475	272	69	50	969	827	684	529	354	6
		1,327	1,062	796	515	191	80	1,551	1,323	1,095	867	639	89
		1,659	1,327	995	664	272	100	1,939	1,654	1,369	1,083	798	145
		2,322	1,858	1,393	929	434	140	2,714	2,315	1,916	1,517	1,118	257
		3,318	2,654	1,991	1,327	664	200	3,878	3,307	2,737	2,167	1,597	424
		4,147	3,318	2,488	1,659	829	250	4,847	4,134	3,422	2,709	1,996	564
		4,977	3,981	2,986	1,991	995	300	5,817	4,961	4,106	3,250	2,395	684
		6,636	5,309	3,981	2,654	1,327	400	7,755	6,615	5,474	4,334	3,193	912
		8,295	6,636	4,977	3,318	1,659	500	9,694	8,269	6,843	5,417	3,992	1,141
		9,954	7,963	5,972	3,981	1,991	600	11,633	9,922	8,212	6,501	4,790	1,369
13,271	10,617	7,963	5,309	2,654	800	15,511	13,230	10,949	8,668	6,387	1,825		
16,589	13,271	9,954	6,636	3,318	1,000	19,389	16,537	13,686	10,835	7,984	2,281		

Special configurations on request: Special tank > 5,000 litres; special tank > 10 bar

## Selecting expansion lines

Expansion lines are to be sized and installed in accordance with local provisions. DIN EN 12828 requires that, each heat generator is connected to at least one expansion line with one or more expansion vessels. It is essential to ensure frost-free conditions.

Expansion lines	DN 25 1"	DN 32 1¼"	DN 40 1½"	DN 50 2"	DN 65	DN 80	DN 100
$\dot{Q}/kW$ Lengths ≤ 10 m	2,100	3,600	4,800	7,500	14,000	19,000	29,000
$\dot{Q}/kW$ Lengths > 10 m ≤ 30 m	1,400	2,500	3,200	5,000	9,500	13,000	20,000

If the length of the expansion line is >10 m, we recommend selecting the nominal diameter one dimension larger.

## Comprehensive calculation and design notes

Before selecting the products, first collate the most important system data for temperature, pressure and water content and calculate the parameters for selecting the products from this information.

Water volume	$V_A$
Heat output	$\dot{Q}_{ges}$
Expansion volume flow	$\dot{V}_e$
Water uptake volume	$V_0$
Safety valve actuating pressure	$p_{sv}$
Minimum operating pressure	$p_0$
Final pressure	$p_E$

- The necessary basic data are preferable to be taken from the design documents/manufacturer's data. If these are not available, the data must be collected on site or estimated. Proxy values for calculating and estimating the water volumes are given in the tables. The extreme requirements of industrial heat supply and district heat supply can be accommodated thanks to the Variomat Giga.

### Proxy values for calculation

#### Coefficient of expansion $n$ for anti-freeze additives\* $z$

$z$	$t_{max}$ °C	30	40	50	60	70	80	90	100	105	110	120	130	140	150
0%	$n$ %	0.37	0.72	1.15	1.66	2.24	2.88	3.58	4.34	4.74	5.15	6.03	6.96	7.96	9.03
34%		1.49	1.99	2.53	3.11	3.71	4.35	5.01	5.68	-	6.39	7.11	7.85	8.62	9.41

\* Values apply for Antifrogen N. We recommend a concentration of 25 to 50 %. Lower doses lead to a risk of corrosion!

#### Evaporation pressure\*\* $p_0$ for anti-freeze additives\* $z$

$z$	$t_{max}$ °C	30	40	50	60	70	80	90	100	105	110	120	130	140	150
0%	$p_0$ bar	-0.96	-0.93	-0.88	-0.80	-0.69	-0.53	-0.3	0.01	0.21	0.43	0.98	1.7	2.61	3.76
34%				-0.90	-0.80	-0.70	-0.60	-0.40	-0.10	-	0.23	0.70	1.33	2.13	3.15

\* Values apply for Antifrogen N. We recommend a concentration of 25 to 50 %. Lower doses lead to a risk of corrosion!

\*\*  $p_0$  with respect to  $\pm 0$  m NN, we recommend an additional 0.1 bar for each 1 km height.

#### Standard values for sizing expansion lines, make-up pipes and lines to control vessel

DN		20	25	32	40	50	65	80	100
$\dot{V}$ l/h	1	630	1,040	1,830	2,410	3,700	6,960	9,450	14,130
	2	2,500	4,150	7,300	9,600	14,800	27,800	37,800	56,500

$\dot{V}$  permissible volume flow: 1 up to a maximum line length of 30 m  
 2 for a line length up to 1 m and to reductions, e.g. to vessel connections.  
 Not permissible for pressure controlled devices between pressure sensors and systems



When using anti-freeze, we recommend remaining within 25–50% glycol in order to minimise the risk of corrosion.

### Estimating the volume of water in heat generators

The volume of water  $V_w$  is calculated from the volume of water  $v_w$  and the nominal performance of the heat generator  $\dot{Q}_w$  or from the installed collector area in solar panels  $A_G$ .

Conventional heat generators	$v_w$ l/kW	
Cast iron boiler with atmospheric burner	1.10	$V_w = v_w \cdot \dot{Q}_w$
Cast iron boiler with forced-air burner	1.40	
Steel boiler with forced-air burner	1.80	
Solid fuel boiler	2.00	
Wall-mounted condensing boiler	0.15	
Heat exchanger	0.60	
CHP	0.60	
Heat pump	0.60	
Solar panels	$v_k$ l/m <sup>2</sup>	
Flat panel	2.0	$V_k = v_k \cdot A_G$
Direct vacuum tube	1.0	
Heat-pipe vacuum tube	3.0	

### Estimating the volume of water in heat surfaces and distribution lines

The volume of water  $V_A$  is determined from the specific volume of water  $v_A$  and the installed output of the heat consumer unit  $\dot{Q}_{ges}$ . It includes the water content of the heating surfaces, the distribution pipes and the pipelines in the central heating system. Pipelines between the central heating plant and the heating system should be considered separately.

Types of heating surface	$t_{max C}   t_R$ °C	90   70	70   55	70   50	55   45	45   35	35   30	
Elements	$v_A$ l/kW	11.5	17.6	18.1	27.7	44.6	83.3	$V_A = v_A \cdot \dot{Q}_{ges}$
Pipes		15	23.2	24.1	36.3	59.3	111.5	
Plates		6.5	9.6	9.4	14.9	21.9	41.0	
Convectors		4	5.9	5.4	9.4	13.4	27.1	
Ventilation		3.3	4.7	4.1	7.4	9.8	19.7	
Underfloor heating system		–	–	–	–	21.1	35.6	

### Volume of vacuum spray pipe degasser $V_D$ , which has to be absorbed by pressure maintenance

Degassing	$V_D$ l
Servitec 25...30	1
Servitec 35...120	6
Special Servitec ... – 2...4	35
Special Servitec ... – 6...8	70

### Specific volume of water $V_p$ in pipelines

The volume of water  $V_p$  is determined from the specific volume of water  $v_p$  and the length of the installed pipeline L.

Example for steel pipelines

DN	25	32	40	50	60	65	80	100	125	150	200
$v_p$ l/m	0.58	1.01	1.34	2.1	3.2	3.9	5.3	7.9	12.3	17.1	34.2

Example for plastic pipelines (PE\_X pipes)

Model	20 × 2	25 × 2.3	32 × 2.9	40 × 3.7	50 × 4.6	63 × 5.8	75 × 6.8	90 × 8.2	110 × 10
$d_i$ in mm	16	20	26	33	41	51	61	74	90
$v_p$ l/m	0.20	0.33	0.54	0.83	1.31	2.07	2.96	4.25	6.36



## Expansion vessels in heating systems

### Calculation

To DIN 4807 T2 and DIN EN 12828.

### Circuit

Usually maintaining suction pressure (☐ see sketch page 30) with upstream flow-through pump and expansion vessel in the return flow, i.e. on the suction side after the flow-through pump.

### Material values $n$ , $p_0$

Generally material values for pure water without anti-freeze.

### Expansion volume $V_e$ , maximum temperature $t_{TR}$

Determine the percentage expansion generally between the minimum temperature = fill temperature = 10 °C and the maximum nominal value setting for the temperature controller  $t_{TR}$ .

### Minimum operating pressure $p_0$

Particularly in the case of low-rise buildings and roof-mounted systems, the minimum supply pressure for the flow-through pump is to be taken from the manufacturer's specifications due to the low static pressure  $p_{st}$ . We also recommend a minimum operating pressure  $p_0$  of no less than 1 bar is selected for lower static heads.

**Note:** Take care with low-rise buildings and roof-mounted systems

Reflex recommendation:  $p_0 \geq 1$  bar

### Filling pressure $p_f$ , supply pressure $p_s$

As the the filling temperature of 10 °C is generally the lowest system temperature, the filling pressure = the supply pressure for the expansion vessel. In pressure maintenance stations, it should be noted that the filling and make-up devices may have to run against the final pressure in some circumstances. This is only the case with Reflexomat.

### Pressure maintenance

Static pressure maintenance with Reflex N, F, S, G also in combination with make-up and degassing systems or as Variomat pressure maintenance station for pressure maintenance, degassing and make-up or as Reflexomat compressor controlled pressure maintenance station.

### Degassing, venting, make-up

In order to achieve permanently safe automatic operation of the heating system, it is advisable to fit the pressure maintenance devices with make-up systems and to supplement this with Servitec degassing systems.

### Auxiliary vessel

If a temperature of 70 °C is permanently exceeded at the pressure maintenance, an auxiliary vessel must be installed in order to protect the bladders.

### Individual protection

According to DIN EN 12828, each heat generator must be connected to at least one expansion vessel. Only secured shut-offs (against unintentional closure) are permitted. If a heat generator is hydraulically blocked (e.g. sequential switching of the boiler), the connection to an expansion vessel must still be guaranteed. In systems with more than one boiler, each boiler is therefore usually secured with its own expansion vessel. This is only calculated for the respective boiler water content.



Due to the good degassing performance of Variomat pressure maintenance stations, we recommend to install an expansion vessel (e.g. Reflex N) is installed at the heat generator in order to minimise the switching frequency, even on single boiler systems.



Use Reflex for systems where corrosion is a potential risk.

In systems with oxygen-rich water (e.g. geothermal systems or underfloor heating without any impermeable pipes), Reflex D, Reflex DE or Reflex C is used up to 70 °C as all water-bearing parts are corrosion protected.



In order to achieve permanently safe automatic operation in cooling water systems, it is advisable to fit the pressure maintenance devices with make-up systems and to supplement this with Servitec degassing systems. This is particularly important in cooling water systems as there must be no thermal deaeration effects.



**Expansion vessel calculation in heating systems**

Circuit: Maintaining supply pressure, expansion vessel in the return flow, upstream flow-through pump, follow-up pressure maintenance.

Initial data		see manufacturer's specifications/proxy values for calculation	
Heat generator ... heat output ... volume of water	$\dot{Q}_W$ [kW] $V_W$ [l]	Total for all heat generators	$\dot{Q}_{ges} = \dots k_W$
Design ... inlet temperature ... return flow temperature Volume of water	$t_V$ [°C] $t_R$ [°C] $V_A$ [l]	At $t_R > 70$ °C install auxiliary vessel!	$V_A = \dots$ Litres
Maximum target value setting Temperature controller Anti-freeze additive	$t_{TR}$ [°C] [%]	Percentage expansion n (with anti-freeze additive n*)	n = ... %
Safety temperature limiter	$t_{STB}$ [°C]	Evaporation pressure $p_D$ at > 100 °C (with anti-freeze additive $p_D^*$ )	$p_D = \dots$ bar
Static pressure	$p_{st}$ [bar]		$p_{st} = \dots$ bar
Pressure calculation			
Supply pressure	$p_0$ [bar]	$p_0 = p_{st} + p_D + 0.2$ bar (safety factor) Reflex recommendation: $p_0 \geq 1.0$ bar Req. Check supply pressure for flow-through pump (NPSH value) from manufacturer's specifications and maintenance of permissible operating pressure.	$p_0 = \dots$ bar
Safety valve actuating pressure	$p_{SV}$ [bar]	Reflex recommendation: for $p_{SV} \leq 5$ bar: $p_{SV} \geq p_0 + 1.5$ bar for $p_{SV} > 5$ bar: $p_{SV} \geq p_0 + 2.0$ bar	$p_{SV} = \dots$ bar
Final pressure	$p_e$ [bar]	$p_e \leq p_{SV}$ – final pressure differential for $p_{SV} \leq 5$ bar: $p_e \leq p_{SV} - 0.5$ bar for $p_{SV} > 5$ bar: $p_e \leq p_{SV} - 0.1 \times p_{SV}$	$p_e = \dots$ bar
Expansion vessel			
Expansion volume	$V_e$ [l]	$V_e = \frac{n}{100} \times V_A$	$V_e = \dots$ Litres
Water reservoir	$V_V$ [l]	$V_V = 0.005 \times V_A$ <b>at least 3 l</b> for $V_n > 15$ l minimum water seal volume to standard	$V_V = \dots$ Litres
Nominal volume	$V_n$ [l]	for $V_n > 15$ l: $V_n = (V_e + V_V + V_D^*) \times \frac{p_e + 1}{p_e - p_0}$  for $V_n \leq 15$ l: Water reservoir $V_V \geq 0.2 \times V_n$ $V_n = (V_e + V_V + V_D^*) \times \frac{p_e + 1}{p_e - p_0}$  Note: The pressure factor is used for simplified calculation of the nominal volume, which is larger than the water reservoir + expansion volume by the pressure factor.	$V_n = \dots$ Litres
Control supply pressure	$p_a$ [bar]	$p_a = \frac{p_e + 1}{1 + \frac{(V_e + V_V)(p_e + 1)(n + n_a)}{V_n(p_0 + 1)2n}} - 1$ bar  Precondition: $p_a \geq p_0 + 0.25 \dots 0.3$ bar, otherwise calculate for larger nominal volume	$p_a = \dots$ bar
Result			
Reflex ... / ... bar ...litres		$p_0 = \dots$ bar Check before commissioning!	
		$p_a = \dots$ bar Check make-up setting!	
		$p_e = \dots$ bar	

\* Only applies when using Reflex Servitec in accordance with the 'Degassing' table,  see page 23.



## Expansion vessels in cooling water systems

The calculation is carried out in accordance with DIN EN 12828 and DIN 4807 part 2.

### Material values $n^*$

Anti-freeze additives (recommendation: 25–50 % concentration), depending on the lowest temperature of the system, must be taken into consideration when determining the percentage expansion  $n^*$  according to the manufacturer's specifications.

### Expansion volume $V_e$

Determination of the percentage expansion  $n^*$  generally between the lowest system temperature (e.g. downtime during winter  $-20\text{ }^\circ\text{C}$ ) and the highest system temperature (e.g. downtime during summer  $+40\text{ }^\circ\text{C}$ ).

### Minimum operating pressure (supply pressure) $p_0$

As temperatures do not exceed  $100\text{ }^\circ\text{C}$ , special factors are not required.

### Filling pressure $p_f$ , supply pressure $p_a$

The lowest system temperature is frequently less than the filling temperature which means the filling pressure is greater than the supply pressure.

### Pressure maintenance

Generally used for static pressure maintenance with Reflex, also in combination with Control and Servitec make-up and degassing stations.

### Degassing, venting, make-up

In order to achieve permanently safe automatic operation in cooling water systems, it is advisable to fit the pressure maintenance devices with make-up systems and to supplement this with Servitec vacuum spray pipe degassing systems. This is particularly important in cooling water systems as there must be no thermal deaeration effects.

### Auxiliary vessels

The Reflex bladders are suitable for temperatures as low as  $-20\text{ }^\circ\text{C}$  and the vessels to  $-10\text{ }^\circ\text{C}$  however, this does not mean the bladder will not 'freeze up' in the vessel. We therefore recommend an auxiliary vessel is installed in the return flow to the chiller at temperatures  $\leq 0\text{ }^\circ\text{C}$ .

### Individual protection

As with heating systems, we recommend individual protection if there is more than one chiller.



In order to achieve permanently safe automatic operation in cooling water systems, it is advisable to fit the pressure maintenance devices with make-up systems and to supplement this with Servitec degassing systems. This is particularly important in cooling water systems as there must be no thermal deaeration effects.

**Expansion vessel calculation in cooling water systems**

Circuit: Maintaining supply pressure, expansion vessel on the suction side, flow-through pump, with follow-up pressure maintenance.

Initial data		see manufacturer's specifications/proxy values for calculation	
Return flow temperature	$t_R$ [°C]	To the chiller; at $t_R > 70$ °C install auxiliary vessel!	
Inlet temperature	$t_V$ [°C]	From the chiller	
Minimum system temp.	$t_{Smin}$ [l]	e.g. downtime during winter	
Maximum system temp.	$t_{Smin}$ [l]	e.g. downtime during summer	
Anti-freeze additive	[%]	Percentage expansion with anti-freeze additive $n^*$	$n^* = \dots \%$
Percentage expansion	[%]	Between minimum temperature (-20 °C) and filling temperature (usually 10 °C)	$n^*F = \dots \%$
Static pressure	$p_{st}$ [bar]		$p_{st} = \dots \text{ bar}$
<b>Pressure calculation</b>			
Supply pressure	$p_0$ [bar]	$p_0 = p_{st} + 0.2$ bar (safety factor) Reflex recommendation: $p_0 \geq 1.0$ bar Check permissible operating pressure is maintained.	$p_0 = \dots \text{ bar}$
Safety valve actuating pressure	$p_{SV}$ [bar]	Reflex recommendation: for $p_{SV} \leq 5$ bar: $p_{SV} \geq p_0 + 1.5$ bar for $p_{SV} > 5$ bar: $p_{SV} \geq p_0 + 2.0$ bar	$p_{SV} = \dots \text{ bar}$
Final pressure	$p_e$ [bar]	$p_e \leq p_{SV}$ - final pressure differential to TRD 721 for $p_{SV} \leq 5$ bar: $p_e \leq p_{SV} - 0.5$ bar for $p_{SV} > 5$ bar: $p_e \leq p_{SV} - 0.1 \times p_{SV}$	$p_e = \dots \text{ bar}$
<b>Expansion vessel</b>			
System volume	$V_A$ [l]	$V_A =$ chiller + cooling coil + pipelines + buffer storage + other	$V_A = \dots \text{ litres}$
Expansion volume	$V_e$ [l]	$V_e = \frac{n^*}{100} \times V_A$	$V_e = \dots \text{ litres}$
Water reservoir	$V_V$ [l]	$V_V = 0.005 \times V_A$ <b>at least 3 l</b> for $V_n > 15$ l minimum water seal volume to standard	$V_V = \dots \text{ litres}$
Nominal volume	$V_n$ [l]	for $V_n > 15$ l: $V_n = (V_e + V_V + V_D^*) \times \frac{p_e + 1}{p_e - p_0}$ for $V_n \leq 15$ l: Water reservoir $V_V \geq 0.2 \times V_n$ $V_n = (V_e + V_V + V_D^*) \times \frac{p_e + 1}{p_e - p_0}$	$V_n = \dots \text{ litres}$
Control Supply pressure	$p_a$ [bar]	$p_a = \frac{p_e + 1}{1 + \frac{(V_V + V_n)(p_e + 1)}{V_n(p_0 + 1)}} - 1$ bar  Precondition: $p_a \geq p_0 + 0.25 \dots 0.3$ bar, otherwise calculate for larger nominal volume	$p_a = \dots \text{ bar}$
Filling pressure	$p_f$ [bar]	$p_f = V_n \times \frac{p_0 + 1}{V_n - V_A \times n^* - V_V} - 1$ bar	$p_f = \dots \text{ bar}$
<b>Result</b>			
Reflex ... / ... bar ... litres		$p_0 = \dots \text{ bar}$ Check before commissioning!	
		$p_a = \dots \text{ bar}$ Check make-up setting!	
		$p_f = \dots \text{ bar}$ Refill the system!	
		$p_e = \dots \text{ bar}$	

\* Only applies when using Reflex Servitec in accordance with the 'Degassing' table, see page 23.



## Expansion vessels in solar systems

The calculation is carried out in accordance with VDI 6002 and DIN 4807 part 2.

Solar systems have a peculiarity in that the maximum temperature cannot be defined by the controller on the heat generator but is determined by the downtime temperature on the panel.

### Nominal volume calculation without evaporation in the panel

The percentage expansion  $n^*$  and the evaporation pressure  $p_D^*$  are related to the downtime temperature. As a temperature of over 200 °C can be reached on certain panels, this calculation procedure is no longer valid at this point. Some indirectly heated pipe panels (system heat pipe) systems have a limit on the downtime temperature. If a minimum operating pressure of  $p_0 \leq 4$  bar is sufficient to avoid evaporation, the calculation can usually be completed with evaporation. In this variant, it should be noted that increased temperature loading reduces the anti-freeze effect of the heat transfer medium in the long term.

### Nominal volume calculation with evaporation in the panel

Evaporation cannot be excluded in panels with downtime temperatures over 200 °C. The evaporation pressure is only taken into consideration up to the required evaporation point (110–120 °C). In this instance, the total panel volume  $V_K$  is taken into consideration in addition to the expansion volume  $V_e$  and the water reservoir  $V_v$  when determining the nominal volume of the expansion vessel. This variant is preferred as the lower temperature places less strain on the heat transfer medium and the frost protection effect has a longer duration.

### Material values $n^*$ , $p_D^*$

Anti-freeze additives of up to 40 % are to be taken into consideration when establishing the percentage expansion  $n^*$  and the evaporation pressure  $p_D^*$  in accordance with manufacturers' specifications. If evaporation is included in the calculation, the evaporation pressure  $p_D^*$  is taken into account up to the boiling point of 110 °C or 120 °C. The percentage expansion  $n^*$  is then determined between the lowest external temperature (e. g. –20 °C) and the boiling temperature. If evaporation is not included in the calculation, the evaporation pressure  $p_D^*$  and the percentage expansion  $n^*$  are dependent on the downtime temperature of the panel.

### Supply pressure $p_0$ , minimum operating pressure

Depending on the calculation method, the minimum operating pressure (= supply pressure) is adjusted to the downtime temperature in the panel (= without evaporation) or the boiling temperature (= with evaporation). In both cases, the usual circuit for the circulating pump  $\Delta p_p$  stated above is to be taken into consideration as the expansion vessel is connected downstream of the flow-through pump on the pressure side (follow-up pressure maintenance).

### Filling pressure $p_f$ , supply pressure $p_s$

The filling temperature (10 °C) is usually well above the minimum system temperature which means the filling pressure is greater than the supply pressure.

### Auxiliary vessels

If a stable return flow temperature of  $\leq 70$  °C cannot be guaranteed on the consumer side, an auxiliary vessel is to be installed on the expansion vessel.

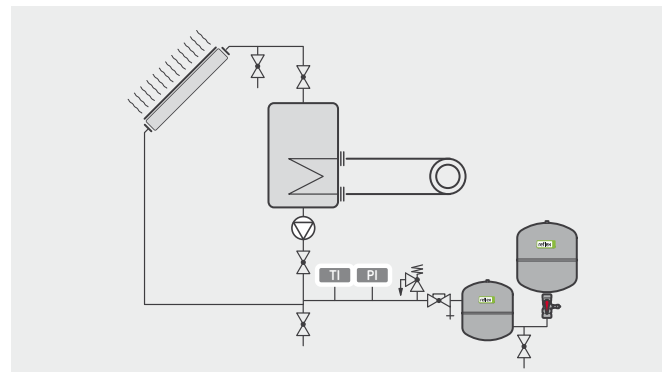



**Expansion vessel calculation in solar systems**

Circuit: follow-up pressure maintenance, expansion vessel in the return flow to the panel.

Initial data		see manufacturer's specifications/proxy values for calculation	
Panels			
Volume of water	$V_k$ [l]	Total of all panels	$V_{Kges} = \dots$ litres
Maximum inlet temp.	$t_v$ [°C]	(110 °C or 120 °C for solar systems with evaporation)	
Minimum external temp.	$t_a$ [°C]	-20 °C	
Anti-freeze additive	[%]	Percentage expansion with anti-freeze additive $n^*$ and evaporation pressure with anti-freeze additive $p_D^*$	$n^* = \dots$ % $p_D^* = \dots$ bar
Percentage expansion	[%]	Between minimum temperature (-20 °C) and filling temperature (usually 10 °C)	$n^*F = \dots$ %
Static pressure	$p_{st}$ [bar]		$p_{st} = \dots$ bar
Differential at the flow-through pump	$\Delta p_p$ [bar]	Evaporation pressure $p_D$ at > 100 °C (For anti-freeze additive $p_D^*$ ) Req. Check supply pressure for flow-through pumps according to manufacturers' specifications.	$\Delta p_p = \dots$ bar
Pressure calculation			
Supply pressure	$p_0$ [bar]	$p_0 = p_{st} + \Delta p_p + p_D^*$ Check permissible operating pressure is maintained.	$p_0 = \dots$ bar
Safety valve actuating pressure	$p_{SV}$ [bar]	Reflex recommendation: for $p_{SV} \leq 5$ bar: $p_{SV} \geq p_0 + 1.5$ bar for $p_{SV} > 5$ bar: $p_{SV} \geq p_0 + 2.0$ bar	$p_{SV} = \dots$ bar
Final pressure	$p_e$ [bar]	$p_e \leq p_{SV}$ – final pressure differential to TRD 721 for $p_{SV} \leq 5$ bar: $p_e \leq p_{SV} - 0.5$ bar for $p_{SV} > 5$ bar: $p_e \leq p_{SV} - 0.1 \times p_{SV}$	$p_e = \dots$ bar
Expansion vessel			
System volume	$V_A$ [l]	$V_A =$ cooling coil + pipelines + buffer storage + other	$V_A = \dots$ litres
Expansion volume	$V_e$ [l]	$V_e = \frac{n^*}{100} \times V_A$	$V_e = \dots$ litres
Water reservoir	$V_V$ [l]	$V_V = 0.005 \times V_A$ <b>at least 3 l</b> for $V_n > 15$ l minimum water seal volume to standard	$V_V = \dots$ litres
Nominal volume	$V_n$ [l]	for $V_n > 15$ l: $V_n = (V_e + V_V + V_{Kges}^*) \times \frac{p_e + 1}{p_e - p_0}$  for $V_n \leq 15$ l: Water reservoir $V_V \geq 0.2 \times V_n$ $V_n = (V_e + V_V + V_{Kges}^*) \times \frac{p_e + 1}{p_e - p_0}$	$V_n = \dots$ litres
Control Supply pressure	$p_a$ [bar]	$v_{pa} = \frac{p_e + 1}{1 + \frac{(V_e + V_{Kges}^*)(p_e + 1)}{V_n(p_0 + 1)2n}} - 1$ bar  <b>Precondition: <math>p_a \geq p_0 + 0.25 \dots 0.3</math> bar, otherwise calculate for larger nominal volume</b>	$p_a = \dots$ bar
Filling pressure	$p_f$ [bar]	$p_f = V_n \times \frac{p_0 + 1}{V_n - V_A \times n_f^* - V_V} - 1$ bar	$p_f = \dots$ bar
Result			
Reflex S / ... bar ... litres		$p_0 = \dots$ bar Check before commissioning!	
		$p_a = \dots$ bar Check make-up setting!	
		$p_f = \dots$ bar Refill the system!	
		$p_e = \dots$ bar	

\* Only applies when using Reflex Servitec in accordance with the 'Degassing' table, see page 23

# Installation and commissioning

## Hydraulic integration

- Integration should preferably be on the suction side of the flow-through pump and in the return flow to the boiler, solar panel or chiller
- At return temperatures of  $> 70\text{ }^\circ\text{C}$  a V auxiliary vessel is required, at return temperatures of  $< 0\text{ }^\circ\text{C}$ , it is recommended.
- Provide a secured shut-off with drain to DIN EN 12828 (applies to all hydraulic systems) for maintenance work (order separately). In larger systems, it is also possible to arrange the drain and shut-off separately.
- Expansion lines are to be sized and installed in accordance with local provisions. DIN EN 12828 requires that each heat generator is connected to at least one expansion line with one or more expansion vessels. It is essential to ensure frost-free conditions.
- Make-up pipes are to be integrated into the flow-through facility water, not into the expansion line.

 The relevant assembly and operating instructions are to be taken into consideration when installing and commissioning.

### Supply pressure maintenance (suction pressure maintenance)

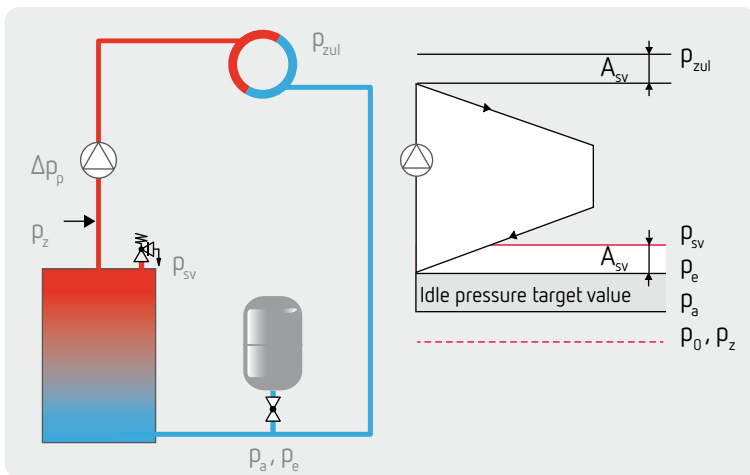

The pressure maintenance is integrated **upstream** of the flow-through pump, i.e. on the suction side. This method is used almost exclusively because it is the easiest to control.

- Benefits:
  - + low idle pressure level
  - + working pressure  $\rightarrow$  idle pressure, therefore no risk of vacuum formation
- Disadvantages:
  - at high flow-through pump pressure (large systems) with high working pressure, observe the network load  $p_{zul}$

### Follow-up pressure maintenance

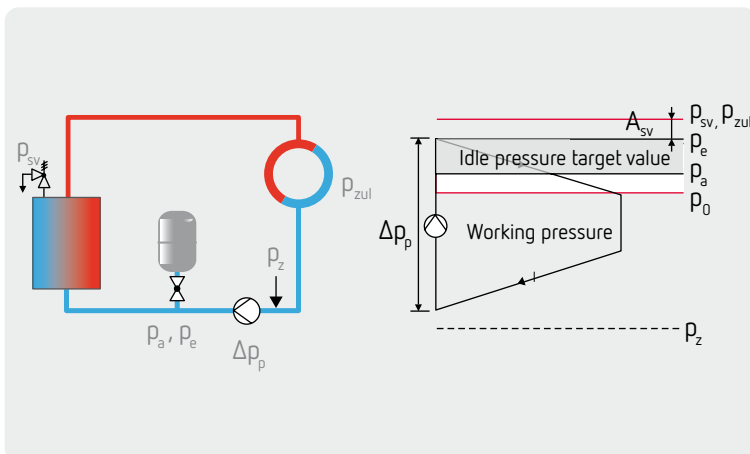

Pressure maintenance is integrated **downstream** of the flow-through pump, i.e. on the pressure side. When determining the idle pressure, a facility-specific differential pressure component for the flow-through pump (50 ... 100 %) must be included in the calculation. For use in only a limited number of cases  $\rightarrow$  solar systems.

- Benefits:
  - + low idle pressure level providing the entire pump pressure does not have to be loaded
- Disadvantages:
  - high idle pressure
  - greater attention to maintaining the required supply pressure  $p_z$  in accordance with manufacturers' specifications

## Integrating multi-boiler systems

It is possible to have either individual protection for each boiler with an expansion vessel or overall boiler and system protection. Care should be taken to ensure the relevant boiler remains connected to at least one expansion vessel when shutting off the boiler's sequential switching. Always agree the best switching sequence with the boiler manufacturer. The system pressure and the medium characteristics (glycol component) must be the same in both circuits.

### Reflex N serial circuit in a multi-boiler system with individual protection

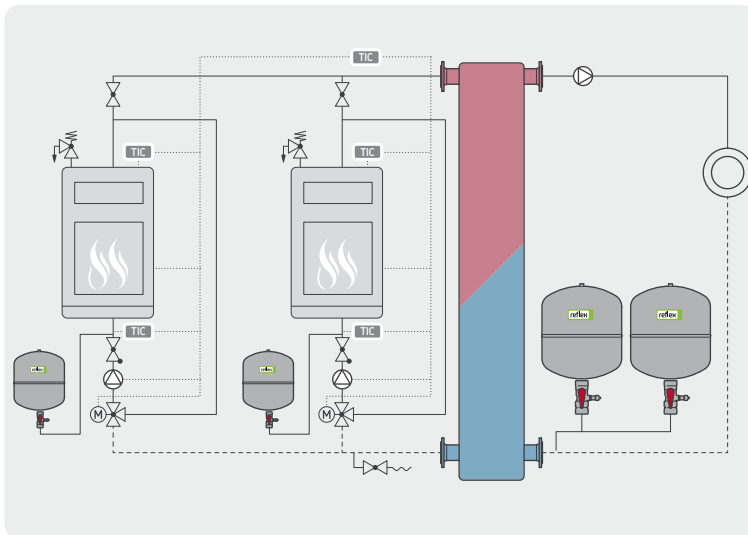

The serial circuit of several Reflex N 6 or 10 bar vessels generally produces economical alternatives to Reflex G large vessels.

With the burner, the corresponding boiler circuit pump is switched off via the temperature control TIC and the motor valve M is closed. The boiler remains connected to its Reflex vessel. The most frequent switching occurs with boilers with minimum return temperature. Switching the burner off reliably prevents circulation via the boiler.

### Reflex in a multi-boiler system with common boiler and system protection

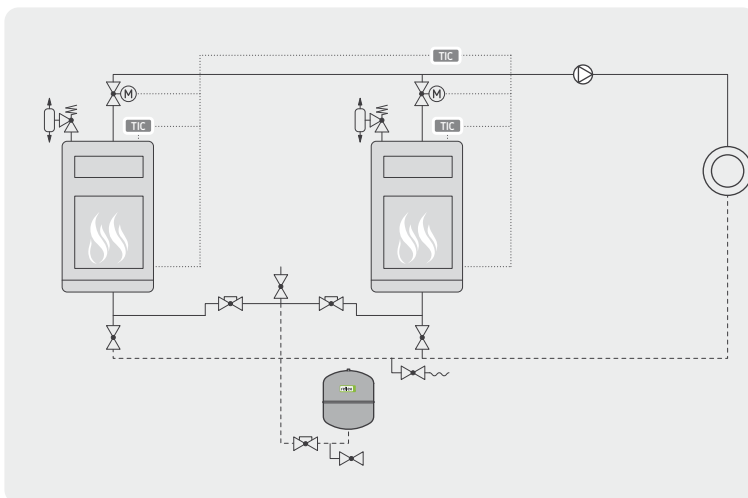

When the burner is switched off, the final control element M is closed by the temperature controller TIC preventing incorrect circulation via the shut-off boiler. Joining the boiler expansion line above the centre of the boiler prevents gravity circulation. Preferred inset in systems without minimum boiler return flow temperature (e.g. condensing boiler systems).

The diagrams serve only as illustrations of the connections. They are to be amended to local conditions and to be made more specific.

## Systems with pipework at risk of corrosion

### Underfloor heating without any impermeable pipes

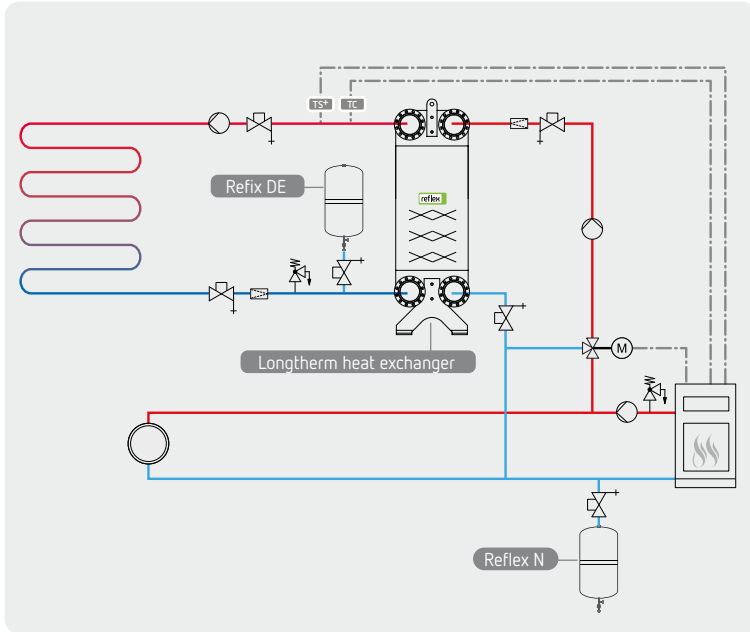

- In systems with oxygen-rich water such as underfloor heating without any impermeable pipes, we recommend the systems are separated (separate the boiler heating circuit medium from the oxygenrich underfloor heating circuit medium) using a Reflex Longtherm heat exchanger.
- A Reflex expansion vessel is used in underfloor heating circuits due to the risk of corrosion (corrosion protection for all water-bearing parts).

### Maintaining VDI 2035

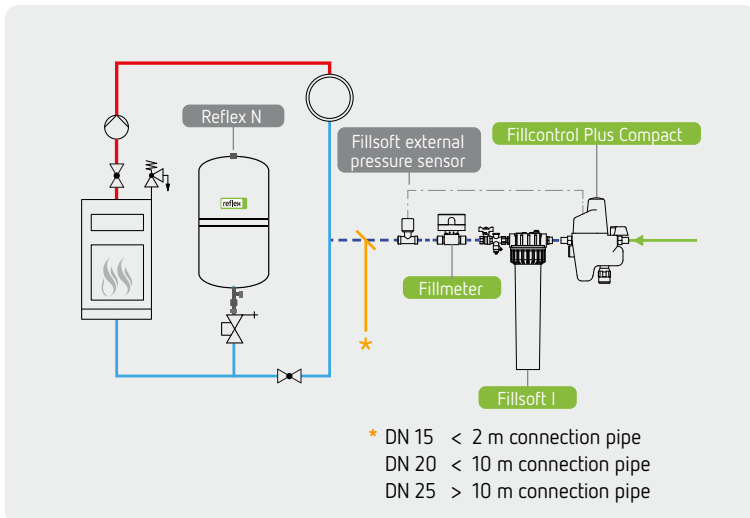

- To ensure compliance with VDI 2035, use a Reflex Fillsoft housing with a softening or demineralising cartridge (depending on the quality of the water or the specifications of the operator/boiler manufacturer).
- The Fillcontrol Plus Compact automatic make-up station which also has a system separator for the potable water supply system ensures an adequate water reservoir.



The directive VDI 2035 describes the state of the art for water quality in hot water heating systems and contributes to minimising damage due to corrosion and scale deposits in these systems. The Fillsoft series of Reflex products comply with this directive. Further information can be found in our Make-up and Water Treatment brochure.

# Installation examples

## Reflex vessel with automatic make-up

Solution № 01

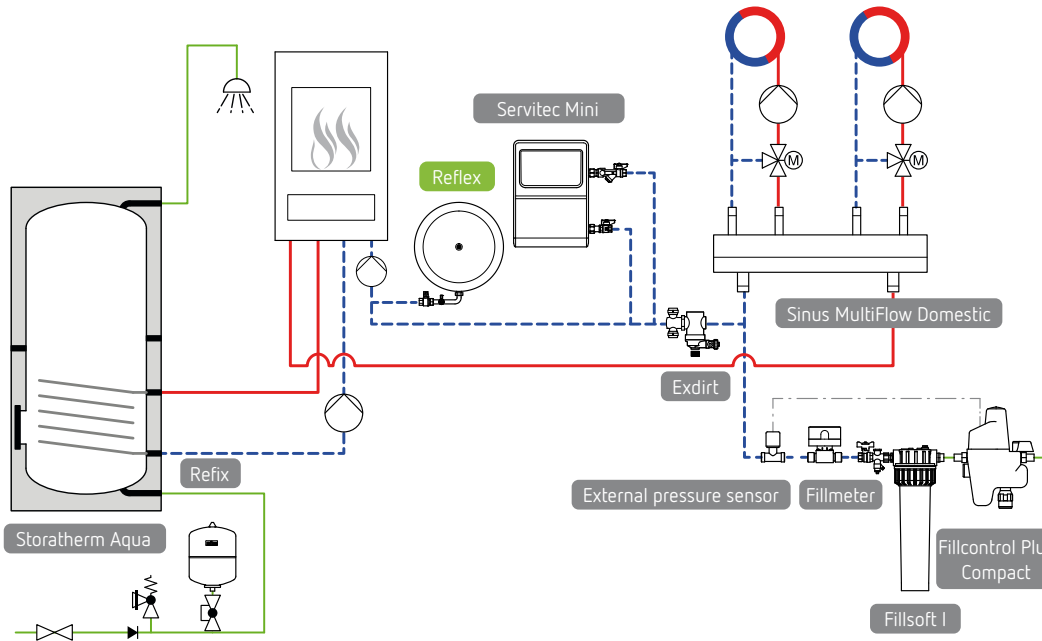

We recommend the use of an automatic make-up such as Reflex Fillcontrol Plus Compact combined with static pressure maintenance in order to ensure an adequate water seal.

Servitec vacuum spray pipe degassing and the dirt and sludge separators remove disruptive factors such as gasses and dirt from the facility water.

## Reflex with flaw detector

Solution № 04

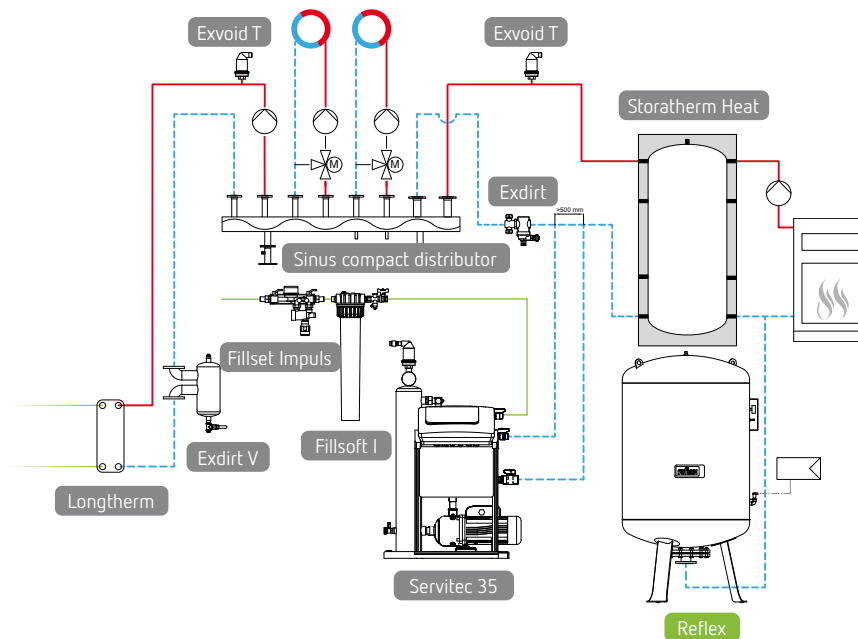

Reflex vessel with flaw detector for monitoring the bladder (from 1,000 litres and Ø1,000mm).

A Longtherm heat exchanger is used to separate the heating and potable water circuit.

Fillset Impuls acts as a system separator to the potable water supply system. The contact water meter for determining filling and make-up quantities is connected with the Servitec controller and evaluated by it.



# Operation & Maintenance

Industrial Safety Regulations require expansion vessels to be checked on an annual basis. The relevant notes for installers and operators in the Reflex Assembly, Operating and Maintenance Instructions are to be observed.

## 1. Visual inspection

- Inspect vessel for damage, corrosion, etc.  
In the event of damage, complete repairs or replace and determine the possible cause.
- Match vessel suitability to on-site use.

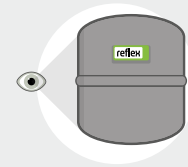

## 2. Check bladder

Briefly activate the gas filling valve. If water leaks out:

- For vessels which do not have a facility for replacing the bladder, replace the expansion vessel.
- for vessels which have a facility for replacing the bladder, replace the bladder or alternatively contact Reflex Service for further advice.

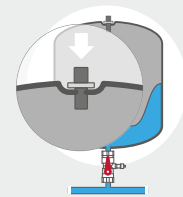

## 3. Setting gas supply pressure

Isolate the Reflex vessel from the system using the cap valve and empty on the water side (check system pressure).

Measure supply pressure  $p_0$  at the gas filling valve and if necessary reset to the required minimum operating pressure for the system.

$$p_0 [\text{bar}] = p_{st} + 0.2 \text{ bar} + p_0^* + \Delta p_p^{**}$$

\* Evaporation pressure  $p_0$  only relevant for hot water systems  $>100^\circ\text{C}$ .

\*\* Used to maintain follow-up pressure maintenance (expansion vessel downstream of the pump on the pressure) e.g. In solar thermal systems.

- If the pressure is too high, blow off the gas with the gas filling valve.
- If the pressure is too low, refill with nitrogen from a pressurised container.
- Enter the reset or corrected supply pressure  $p_0$  on the type plate.

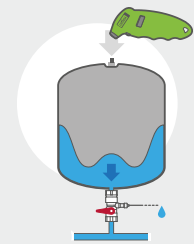

## 4. Functional inspection during operation

- Close drain at the cap valve and carefully open cap valve.
- Note system pressure and do not allow it to fall below  $p_0$ .
- Fill the system up to the filling pressure  $p_f$  in accordance with the system temperature.

$$p_f [\text{bar}] \geq p_0 + 0.3 \text{ bar (at filling temperature } 10^\circ\text{C)}^*$$

- Checking gas pressure during operation: the gas pressure must now be the same as the system pressure (working vessel).

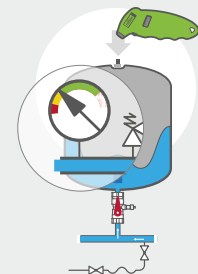

## 5. Gas filling valve leak test

Remove optional aids for filling and measuring at the gas filling valve and inspect with leak test spray to see whether the gas filling valve leaks after use. Finally, refit the cap valve, which provides the seal, on the gas filling valve.

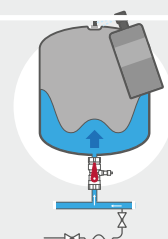

## Key advantages

### High-quality expansion vessels

- Long operating life due to high-quality membrane and stable vessel
- Due to the use of a bladder on all DD, DT, C-DE, DE and hot water vessels, the vessel is not in contact with the medium and is therefore more resistant to corrosion
- Approved in accordance with pressure equipment guidelines 2014/68/EU
- Refix DD and DT meet all the requirements of DIN 4807 T5

### Wide range of designs and application areas

- For potable water, pressure booster systems and water heating systems to DIN 1988
- For heating, heat pump, cooling and solar applications as well as process water applications which do not fall within the scope of DIN 1988.

### Rapid design and installation

- Intuitive design configuration software for rapid selection and calculation
- Vessels are supplied ready for use
- Low-maintenance operation

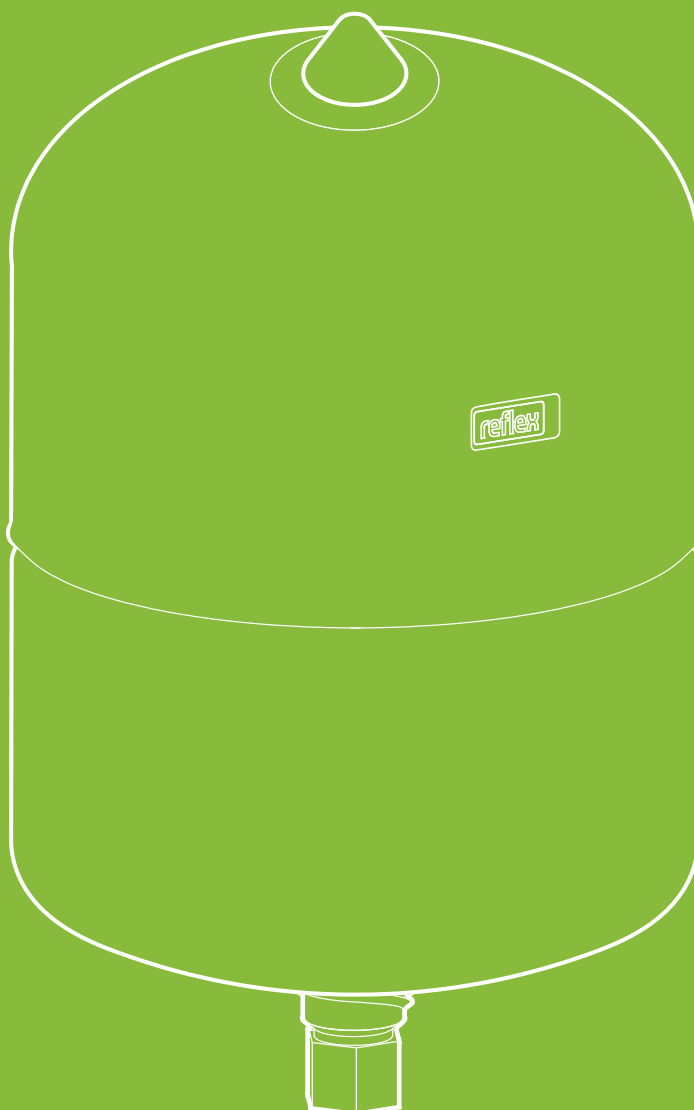

# Refix product portfolio

## Refix DD and Flowjet

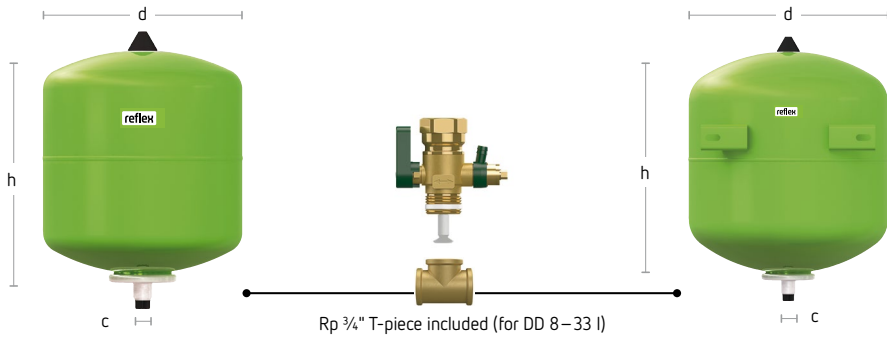

Refix DD with Flowjet flow through, shut-off and drain valve ensures simple and DIN-compliant installation as the Refix vessel can be shut off, drained and flowed through.

DD 2 – 25l

Flowjet flow through, shut-off and drain valve (optional)

DD 33 litres with fixing brackets (rear view)

Technical Features

- For drinking water, pressure-boosting and water heating systems according to DIN 1988
- With stainless steel thread connection
- 33 litres with brackets
- Circulation with high-flow circulation star
- Non-replaceable bladder according to DIN EN 13831, DIN 4807 T5, KTW-C and W270
- Built and tested to DIN 4807 T5, DIN DVGW Reg. No. NW-0411AT2534 (Applicable for 8 – 33 litres and 10/16 bar in combination with Flowjet flow-through valve)
- Approval according to Pressure Equipment Directive 2014/68/EU
- Interior and exterior coating in compliance with KTW-A
- May be combined with the Flowjet—flow through valve
- With factory-pressurised gas chamber
- Vessels certified to WRAS and ACS upon request
- Only for use in cold water pipes** (consider installation and operating instructions)

	Type	Art. No.		DG	PQ [pce]	Inlet pressure [bar]	Connection c	Ø d [mm]	Height h [mm]	Weight [kg]
		green	white							
10 bar 70 °C	DD 2	7381500	–	0048	288	4	G 3/4"	132	269	0.98
	DD 8	7308000	7307700	0048	96	4	G 3/4"	206	345	1.80
	DD 12	7308200	7307800	0048	60	4	G 3/4"	280	318	2.20
	DD 18	7308300	7307900	0048	56	4	G 3/4"	280	418	3.04
	DD 25	7308400	7380400	0048	42	4	G 3/4"	280	528	3.80
	DD 33	7380700	7380800	0048	24	4	G 3/4"	354	468	5.06
16 bar 70 °C	DD 8	7301905	–	0048	96	4	G 3/4"	206	345	1.80
	DD 12	7303805	–	0048	60	4	G 3/4"	280	318	2.30
25 bar 70 °C	DD 8	7290200	7290300	0048	60	4	G 3/4"	206	344	3.45

## Reflex C-DE

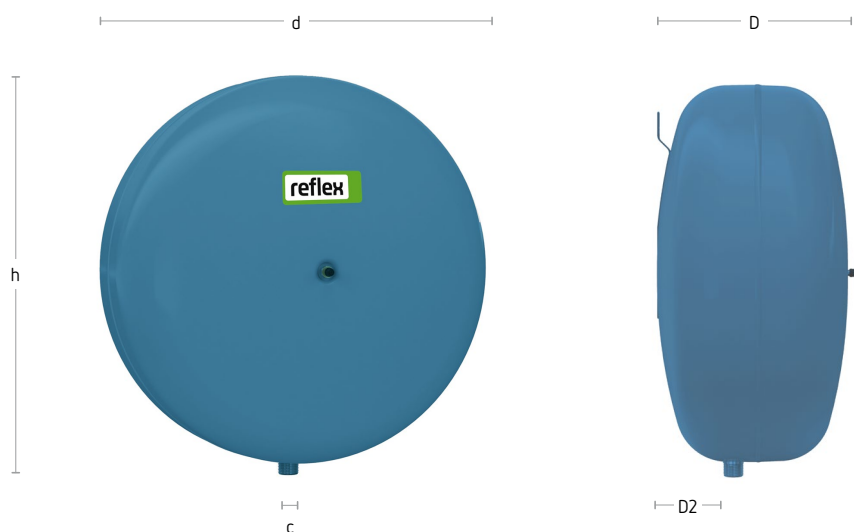

C-DE 8 – 80l

### Technical Features

- Vertical flat disc-shaped shallow vessels for heating, heat pump, cooling and solar applications as well as service water applications **not** required to meet the DIN 1988 requirements
- With stainless steel thread connection
- Non-replaceable bladder according to DIN EN 13831
- No medium circulating, without shut-off
- Parts in contact with water are corrosion-protected
- Approval according to Pressure Equipment Directive 2014/68/EU
- For antifreeze additive of at least 25–50 %
- Durable epoxy resin coating
- With factory-pressurised gas chamber

	Type	Art. No.	DG	PQ	Inlet pressure	Connection	Ø d	Height h	Depth D	Depth D2	Weight
		blue		[pce]	[bar]	c	[mm]	[mm]	[mm]	[mm]	[kg]
10 bar 70 °C	C-DE 8	7270900	0017	96	4	G ½"	280	296	176	52	2.70
	C-DE 12	7270910	0017	60	4	G ½"	354	370	182	64	4.87
	C-DE 18	7270920	0017	42	4	G ¾"	356	370	236	76	6.20
	C-DE 25	7270930	0017	42	4	G ¾"	409	427	253	93	8.56
	C-DE 35	7270940	0017	24	4	G ¾"	480	465	256	97	13.00
	C-DE 50	7270950	0017	20	4	G ¾"	480	465	332	125	15.80
	C-DE 80	7270960	0017	8	4	G ¾"	634	621	338	135	23.30

# Refix DT

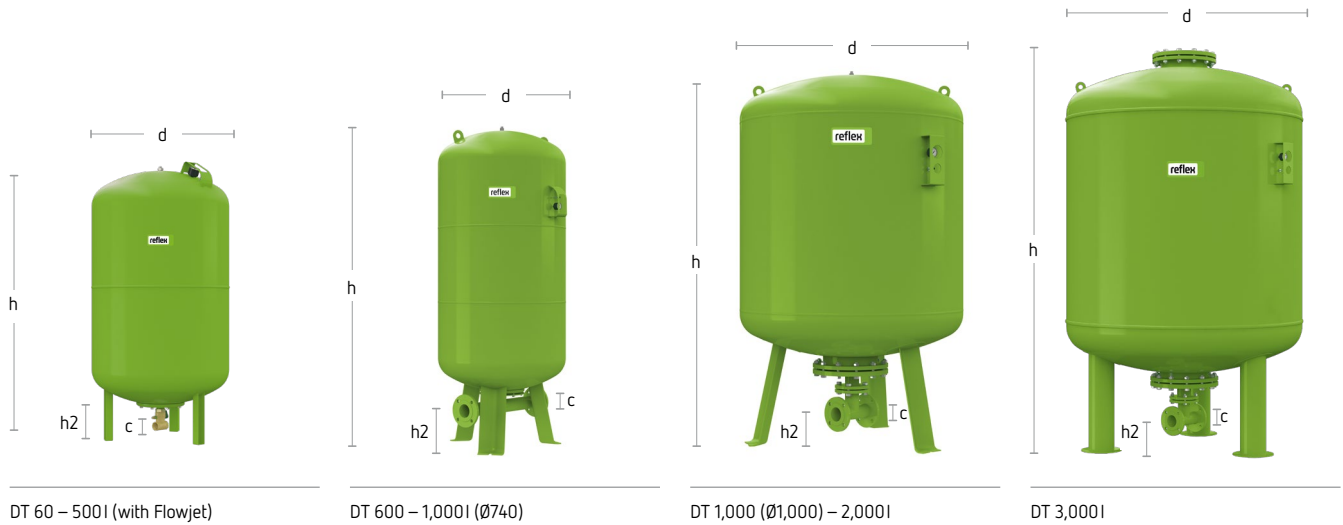

DT 60 – 500l (with Flowjet)

DT 600 – 1,000l (Ø740)

DT 1,000 (Ø1,000) – 2,000l

DT 3,000l

## Technical Features

- For drinking water, pressure-boosting and water heating systems according to DIN 1988
- Flowjet incl. shut-off and draining or dual connection
- Replaceable bladder according to DIN EN 13831, DIN 4807 T5, KTW-C and W270, Built and tested to DIN 4807 T5, DIN DVGW Reg. No. NW-0411BR0350
- Approval according to Pressure Equipment Directive 2014/68/EU
- Interior and exterior coating in compliance with KTW-A
- The following types are equipped with a diaphragm break detector coupling:
  - 10 bar: ≥ 600 l
  - 16 bar
- Pressure gauge and supply pressure valve protected by clip
- With factory-pressurised gas chamber
- Vessels certified to WRAS and ACS upon request
- Only for use in cold water pipes** (consider installation and operating instructions)

	Type	Art. No. green	DG	PQ [pce]	Inlet pressure [bar]	Connection c	Ø d [mm]	Height h [mm]	Height h2 [mm]	Weight [kg]
10 bar 70 °C	DT 60	7309000	0047	1	4	Rp 1 1/4"	409	766	80	15.00
	DT 80	7309100	0047	8	4	Rp 1 1/4"	480	750	56	17.00
	DT 80	7365000	0047	4	4	DN50/PN16	480	750	97	23.70
	DT 80	7335705	0047	4	4	DN65/PN16	480	750	107	24.70
	DT 80	7335805	0047	4	4	DN80/PN16	480	750	115	26.80
	DT 100	7309200	0047	4	4	Rp 1 1/4"	480	834	56	19.20
	DT 100	7365400	0047	4	4	DN50/PN16	480	834	97	26.80
	DT 100	7365405	0047	4	4	DN65/PN16	480	834	107	27.80
	DT 100	7365406	0047	4	4	DN80/PN16	480	834	114	28.90
	DT 200	7309300	0047	1	4	Rp 1 1/4"	634	973	80	37.00
	DT 200	7365100	0047	1	4	DN50/PN16	634	973	105	53.00
	DT 200	7365105	0047	1	4	DN65/PN16	634	973	115	54.00
	DT 200	7365106	0047	1	4	DN80/PN16	634	973	120	57.00
	DT 300	7309400	0047	1	4	Rp 1 1/4"	634	1,273	80	51.00
	DT 300	7365200	0047	1	4	DN50/PN16	634	1,273	105	59.00
	DT 300	7336305	0047	1	4	DN65/PN16	634	1,273	115	60.00
	DT 300	7336405	0047	1	4	DN80/PN16	634	1,273	120	63.00
	DT 400	7319305	0047	1	4	Rp 1 1/4"	740	1,245	69	74.00
	DT 400	7365500	0047	1	4	DN50/PN16	740	1,245	95	80.00
	DT 400	7336505	0047	1	4	DN65/PN16	740	1,245	105	81.00
DT 400	7336605	0047	1	4	DN80/PN16	740	1,245	110	83.00	
DT 500	7309500	0047	1	4	Rp 1 1/4"	740	1,475	69	72.00	
DT 500	7365300	0047	1	4	DN50/PN16	740	1,475	90	88.00	
DT 500	7365307	0047	1	4	DN65/PN16	740	1,475	100	89.00	
DT 500	7365305	0047	1	4	DN80/PN16	740	1,475	110	92.00	

	Type	Art. No.	DG	PQ	Inlet pressure	Connection	Ø d	Height h	Height h2	Weight
		green		[pce]	[bar]	c	[mm]	[mm]	[mm]	[kg]
10 bar 70 °C	DT 600	7365600	0047	1	4	DN50/PN16	740	1,859	233	164.00
	DT 600	7336705	0047	1	4	DN65/PN16	740	1,859	233	165.00
	DT 600	7336806	0047	1	4	DN80/PN16	740	1,859	235	168.00
	DT 800	7365700	0047	1	4	DN50/PN16	740	2,324	233	204.00
	DT 800	7336905	0047	1	4	DN65/PN16	740	2,324	233	205.00
	DT 800	7337006	0047	1	4	DN80/PN16	740	2,324	233	208.00
	DT 1000/740	7365800	0047	1	4	DN50/PN16	740	2,804	233	260.00
	DT 1000/740	7337105	0047	1	4	DN65/PN16	740	2,804	233	261.00
	DT 1000/740	7337205	0047	1	4	DN80/PN16	740	2,804	233	264.00
	DT 1000/1000	7320105	0046	1	4	DN65/PN16	1,000	2,001	160	386.20
	DT 1000/1000	7337305	0046	1	4	DN80/PN16	1,000	2,001	150	386.20
	DT 1000/1000	7337405	0046	1	4	DN100/PN16	1,000	2,001	140	386.20
	DT 1500	7320305	0046	1	4	DN65/PN16	1,200	2,001	158	502.40
	DT 1500	7337505	0046	1	4	DN80/PN16	1,200	2,001	150	502.40
	DT 1500	7337605	0046	1	4	DN100/PN16	1,200	2,001	140	502.40
	DT 2000	7320505	0046	1	4	DN65/PN16	1,200	2,461	158	686.50
	DT 2000	7337705	0046	1	4	DN80/PN16	1,200	2,461	150	686.50
	DT 2000	7337805	0046	1	4	DN100/PN16	1,200	2,461	140	686.50
	DT 3000	7320705	0046	1	4	DN65/PN16	1,500	2,580	187	1,054.00
	DT 3000	7337905	0046	1	4	DN80/PN16	1,500	2,530	180	1,057.00
DT 3000	7338005	0046	1	4	DN100/PN16	1,500	2,530	170	1,057.00	
16 bar 70 °C	DT 80	7316005	0047	4	4	Rp 1 1/4"	480	750	56	27.80
	DT 80	7370000	0047	4	4	DN50/PN16	480	750	97	33.00
	DT 80	7310306	0047	4	4	DN65/PN16	480	750	107	34.00
	DT 80	7310307	0047	4	4	DN80/PN16	480	750	114	36.00
	DT 100	7365408	0047	4	4	Rp 1 1/4"	480	834	56	29.90
	DT 100	7370100	0047	4	4	DN50/PN16	480	834	97	35.00
	DT 100	7370101	0047	4	4	DN65/PN16	480	834	107	36.00
	DT 100	7370102	0047	4	4	DN80/PN16	480	834	114	38.00
	DT 200	7365108	0047	1	4	Rp 1 1/4"	634	973	80	55.00
	DT 200	7370200	0047	1	4	DN50/PN16	634	973	105	61.00
	DT 200	7370205	0047	1	4	DN65/PN16	634	973	115	62.00
	DT 200	7370206	0047	1	4	DN80/PN16	634	973	120	65.00
	DT 300	7319205	0047	1	4	Rp 1 1/4"	634	1,273	115	64.00
	DT 300	7370300	0047	1	4	DN50/PN16	634	1,273	105	70.00
	DT 300	7314205	0047	1	4	DN65/PN16	634	1,273	80	71.00
	DT 300	7314206	0047	1	4	DN80/PN16	634	1,273	120	74.00
	DT 400	7370400	0047	1	4	DN50/PN16	740	1,394	235	115.00
	DT 400	7339006	0047	1	4	DN65/PN16	740	1,394	235	121.00
	DT 400	7339005	0047	1	4	DN80/PN16	740	1,394	235	124.00
	DT 500	7370500	0047	1	4	DN50/PN16	740	1,615	235	136.00
	DT 500	7370507	0047	1	4	DN65/PN16	740	1,615	235	137.00
	DT 500	7370505	0047	1	4	DN80/PN16	740	1,615	235	140.00
	DT 600	7370600	0047	1	4	DN50/PN16	740	1,859	235	174.00
	DT 600	7339105	0047	1	4	DN65/PN16	740	1,859	235	175.00
	DT 600	7339205	0047	1	4	DN80/PN16	740	1,859	235	178.00
	DT 800	7370700	0047	1	4	DN50/PN16	740	2,324	235	224.00
	DT 800	7339305	0047	1	4	DN65/PN16	740	2,324	235	225.00
	DT 800	7339406	0047	1	4	DN80/PN16	740	2,324	235	228.00
	DT 1000/740	7370800	0047	1	4	DN50/PN16	740	2,804	235	275.00
	DT 1000/740	7339505	0047	1	4	DN65/PN16	740	2,804	235	276.00
	DT 1000/740	7339605	0047	1	4	DN80/PN16	740	2,804	235	279.00
	DT 1000/1000	7320205	0046	1	4	DN65/PN16	1,000	2,001	160	488.00
	DT 1000/1000	7339705	0046	1	4	DN80/PN16	1,000	2,001	150	488.00
	DT 1000/1000	7339805	0046	1	4	DN100/PN16	1,000	2,001	140	488.00
	DT 1500	7320405	0046	1	4	DN65/PN16	1,200	2,220	158	630.00
	DT 1500	7339905	0046	1	4	DN80/PN16	1,200	2,220	150	630.00
DT 1500	7340005	0046	1	4	DN100/PN16	1,200	2,220	140	630.00	
DT 2000	7320605	0046	1	4	DN65/PN16	1,200	2,480	158	850.50	
DT 2000	7340105	0046	1	4	DN80/PN16	1,200	2,480	150	850.50	
DT 2000	7340205	0046	1	4	DN100/PN16	1,200	2,480	140	850.50	
DT 3000	7320805	0046	1	4	DN65/PN16	1,500	2,580	187	1,240.00	
DT 3000	7340305	0046	1	4	DN80/PN16	1,500	2,580	180	1,240.00	
DT 3000	7340405	0046	1	4	DN100/PN16	1,500	2,580	170	1,200.00	



## Refix DE

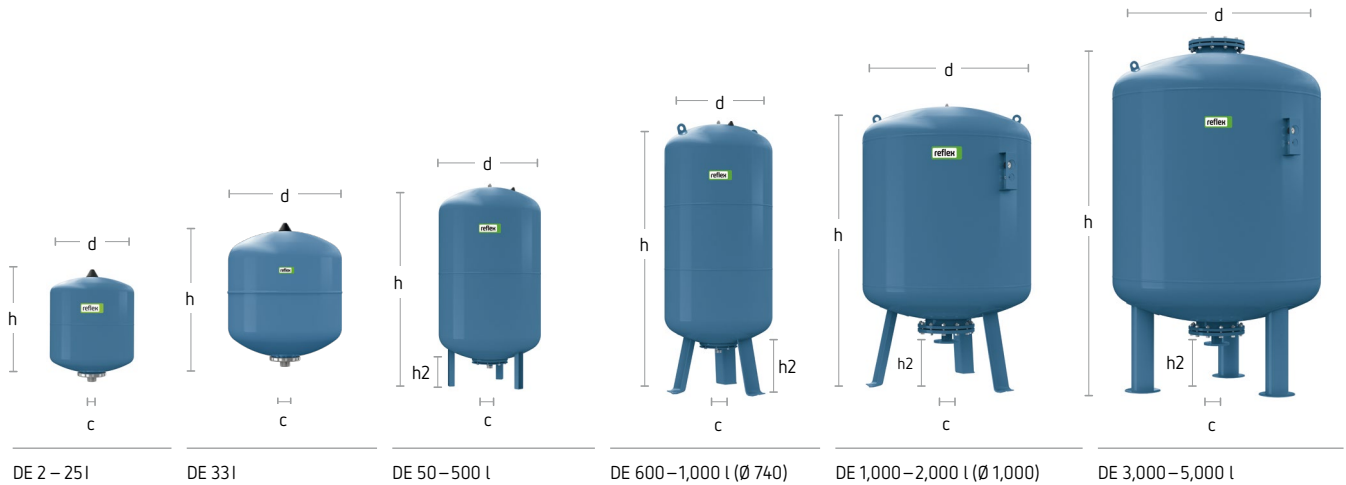

### Technical Features

- Only for systems **not** required to meet DIN 1988, such as fire-fighting and service water systems, underfloor heating and geothermal installations
- Parts in contact with water are corrosion-protected
- Bladder according to DIN EN 13831/replaceable from 50 litres
- No medium circulating, without shut-off and without draining
- From Ø 1,000 mm including pressure gauge
- Pressure gauge and supply pressure valve protected by clip
- Approval according to Pressure Equipment Directive 2014/68/EU
- Durable epoxy resin coating
- With factory-pressurised gas chamber
- Vessels certified to WRAS and ACS upon request
- The following types are equipped with a diaphragm break detector coupling:
  - 10/16 bar: ≥ 1,000 l / Ø 1,000 mm
  - 25 bar: ≥ 80 l

	Type	Art. No.	DG	PQ	Inlet pressure	Connection	Ø	Height	Height	Weight
		blue		[pce]	[bar]	c	d	h	h2	
							[mm]	[mm]	[mm]	[kg]
10 bar 70 °C	DE 2	7200300	0040	288	4	G ¾"	132	260	–	0.98
	DE 8	7301000	0040	96	4	G ¾"	206	332	–	1.80
	DE 12	7302000	0040	60	4	G ¾"	280	310	–	2.16
	DE 18	7303000	0040	56	4	G ¾"	280	407	–	3.27
	DE 25	7304000	0040	42	4	G ¾"	280	518	–	3.75
	DE 33	7303900	0040	24	4	G ¾"	354	457	–	4.95
	DE 33 st	7305500	0040	24	4	G ¾"	354	520	66	5.70
	DE 50	7306005	0042	20	4	G1"	409	604	102	9.27
	DE 60	7306400	0042	18	4	G1"	409	734	161	10.50
	DE 80	7306500	0042	10	4	G1"	480	737	143	12.80
	DE 100	7306600	0042	10	4	G1"	480	852	143	14.80
	DE 200	7306700	0042	4	4	G 1 ¼"	634	967	150	34.80
	DE 300	7306800	0042	1	4	G 1 ¼"	634	1,267	150	41.60
	DE 400	7306850	0042	1	4	G 1 ¼"	740	1,245	139	74.00
	DE 500	7306900	0042	1	4	G 1 ¼"	740	1,475	133	74.00
	DE 600	7306950	0042	1	4	G 1 ½"	740	1,859	263	128.00
	DE 800	7306960	0042	1	4	G 1 ½"	750	2,324	263	176.00
	DE 1000	7306970	0042	1	4	G 1 ½"	740	2,804	261	210.00
	DE 1000	7311405	0044	1	4	DN65/PN16	1,000	2,001	286	308.00
	DE 1500	7311605	0044	1	4	DN65/PN16	1,200	1,991	291	426.00
DE 2000	7311705	0044	1	4	DN65/PN16	1,200	2,451	291	717.00	
DE 3000	7311805	0044	1	4	DN65/PN16	1,500	2,531	320	962.00	
DE 4000	7354000	0044	1	4	DN65/PN16	1,500	3,080	320	1,132.00	
DE 5000	7354200	0044	1	4	DN65/PN16	1,500	3,645	320	1,292.00	

	Type	Art. No. blue	DG	PQ [pce]	Inlet pressure [bar]	Connection c	Ø d [mm]	Height h [mm]	Height h2 [mm]	Weight [kg]
16 bar 70 °C	DE 8	7301006	0040	96	4	G ¾"	206	337	–	2.32
	DE 12	7302105	0040	72	4	G ¾"	280	310	–	3.05
	DE 25	7304015	0040	42	4	G ¾"	280	518	–	5.00
	DE 80	7348600	0042	4	4	G1"	480	744	138	20.12
	DE 100	7348610	0042	4	4	G1"	480	849	132	23.00
	DE 200	7348620	0042	1	4	G 1 ½"	634	967	150	57.00
	DE 300	7348630	0042	1	4	G 1 ½"	634	1,267	150	66.00
	DE 400	7348640	0042	1	4	G 1 ½"	740	1,394	263	118.00
	DE 500	7348650	0042	1	4	G 1 ½"	740	1,614	263	133.00
	DE 600	7348660	0042	1	4	G 1 ½"	740	1,859	263	158.00
	DE 800	7348670	0042	1	4	G 1 ½"	740	2,324	263	202.00
	DE 1000	7348680	0042	1	4	G 1 ½"	740	2,804	263	240.00
	DE 1000	7312805	0044	1	4	DN65/PN16	1,000	2,001	286	530.00
	DE 1500	7312905	0044	1	4	DN65/PN16	1,200	1,991	291	685.00
	DE 2000	7313005	0044	1	4	DN65/PN16	1,200	2,451	291	895.00
	DE 3000	7313105	0044	1	4	DN65/PN16	1,500	2,531	320	1,240.00
	DE 4000	7354100	0044	1	4	DN65/PN16	1,500	3,120	320	1,442.00
DE 5000	7354300	0044	1	4	DN65/PN16	1,500	3,655	320	1,844.00	
25 bar 70 °C	DE 8	7290100	0040	60	4	G ¾"	206	338	–	3.15
	DE 80	7317600	0044	1	4	DN50/PN40	450	942	159	70.00
	DE 120	7313700	0044	1	4	DN50/PN40	450	1,253	159	100.00
	DE 180	7313500	0044	1	4	DN50/PN40	450	1,528	159	116.00
	DE 300	7313800	0044	1	4	DN50/PN40	750	1,318	160	150.00
	DE 400	7313300	0044	1	4	DN50/PN40	750	1,423	160	245.00
	DE 600	7321500	0044	1	4	DN50/PN40	750	1,868	159	290.00
	DE 800	7321200	0044	1	4	DN50/PN40	750	2,268	159	355.00
	DE 1000	7321000	0044	1	4	DN50/PN40	750	2,768	159	245.00
	DE 1000	7322200	0044	1	4	DN65/PN40	1,000	2,051	242	800.00
	DE 1500	7322100	0044	1	4	DN65/PN40	1,200	2,071	291	850.00
	DE 2000	7313400	0044	1	4	DN65/PN40	1,200	2,531	240	960.00
	DE 3000	7345700	0044	1	4	DN65/PN40	1,500	2,619	269	1,550.00

# Reflex DC

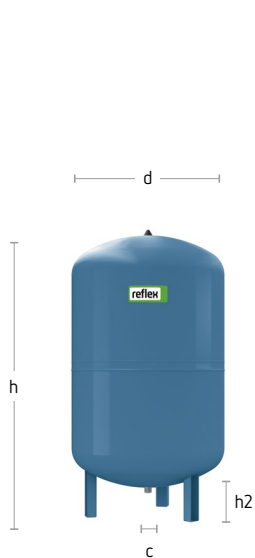

DC 50–400 l

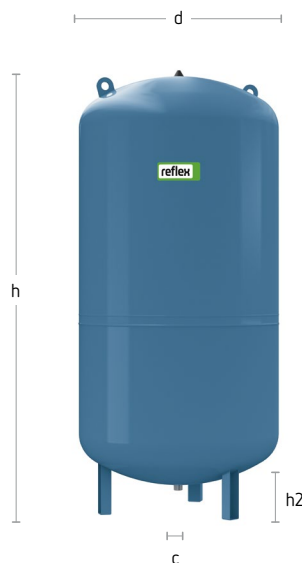

DC 500–600 l

Technical Features

- Only for systems **not** required to meet DIN 1988, such as fire-fighting and service water systems, underfloor heating and geothermal installations
- Parts in contact with water are corrosion-protected
- Non-replaceable diaphragm according to DIN EN 13831
- No medium circulating, without shut-off & without draining
- Approval according to Pressure Equipment Directive 2014/68/EU
- Durable epoxy resin coating
- With factory-pressurised gas chamber
- Vessels certified to WRAS and ACS upon request

	Type	Art. No.	DG	PQ	Inlet pressure	Connection	Ø d	Height h	Height h2	Weight
		blue		[pce]	[bar]	c	[mm]	[mm]	[mm]	[kg]
10 bar 70 °C	DC 25	7200400	0054	42	2	G1"	289	510	–	3.34
	DC 50	7309600	0054	20	4	R 1"	418	588	115	9.35
	DC 80	7309700	0054	12	4	R 1"	489	676	103	12.44
	DC 100	7309800	0054	10	4	R 1"	489	782	103	14.28
	DC 140	7309900	0054	1	4	R 1"	489	997	104	20.30
	DC 200	7363500	0054	1	4	R 1"	643	883	91	29.27
	DC 300	7363600	0054	1	4	R 1"	643	1,184	93	38.00
	DC 400	7363700	0054	1	4	R 1"	749	1,173	81	54.00
	DC 500	7363800	0054	1	4	R 1"	749	1,392	82	71.00
DC 600	7363900	0054	1	4	R 1"	749	1,629	75	80.00	

## Reflex HW

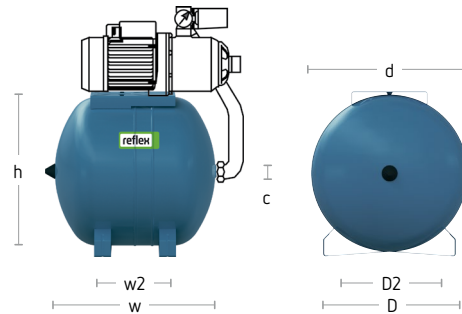

HW 25–100 l

### Technical Features

- As a buffer vessel for domestic water systems not subject to the DIN 1988 requirements
- Parts in contact with water are corrosion-protected
- Bladder according to DIN EN 13831/replaceable from 50 litres
- Max. operating temperature 70 °C
- Approval according to Pressure Equipment Directive 2014/68/EU
- Durable epoxy resin coating
- With factory-pressurised gas chamber
- Vessels certified to WRAS and ACS upon request

	Type	Art. No.	DG	PQ	Inlet pressure	Connection	Ø d	Height h	Width w	Wide w2	Depth D	Depth D2	Weight
		blue		[pce]	[bar]	c	[mm]	[mm]	[mm]	[mm]	[mm]	[mm]	[kg]
10 bar 70 °C	HW 25	7200310	0049	36	1.5	G ¾"	280	301	518	227	270	214	5.05
	HW 50	7200320	0049	20	2.0	G1"	409	432	503	175	350	285	9.00
	HW 60	7200330	0049	16	2.0	G1"	409	432	577	175	350	285	10.00
	HW 80	7200340	0049	16	2.0	G1"	480	504	593	185	350	285	12.50
	HW 100	7200350	0049	16	2.0	G1"	480	504	706	305	350	285	14.06

## Reflex WD

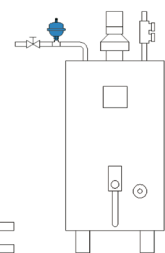
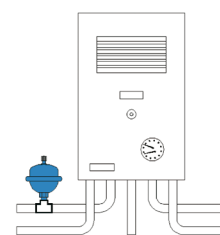
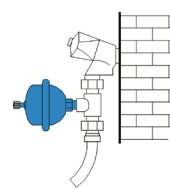
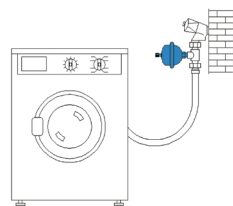
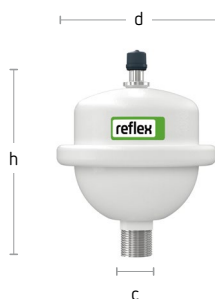

WD 0.165 l

### Technical Features

- For appliances with quick-closing fittings such as washers and dishwashers
- Parts in contact with water are corrosion-protected
- Approval according to Pressure Equipment Directive 2014/68/EU
- Total volume 165 cm<sup>3</sup>
- Non-replaceable diaphragm according to DIN EN 13831
- Max. operating temperature 70 °C
- Vessels certified to WRAS and ACS upon request

	Type	Art. No.	DG	PQ	Inlet pressure	Connection c	Ø d	Height h	Weight
		white		[pce]	[bar]		[mm]	[mm]	[kg]
10 bar 70 °C	WD	7351000	0074	576	3.5	G ½"	83	111	0.30

## Refix accessories

### Flowjet

- Secured shut-off fitting with drain for Refix DD to DIN 4807 T5
- Max. operating pressure 16 bar
- Max. operating temperature 70 °C
- Connections both sides ¾", internal/external threads
- May be combined with user-provided T-pieces
- Nominal passage width: 1"

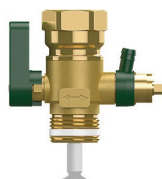

### Wall mounting bracket with clamping strap

- Console with clamping strap for Reflex 6 – 25 litres
- Upright assembly



### AG connection set

- For rapid assembly and maintenance of membrane expansion vessels
- Incl. secured shut-off and connecting bend with screw connection
- With drainage cock (G ½") and hose nozzle
- According to DIN EN 12828
- 10 bar/100 °C

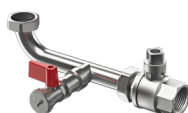

### Digital pressure gauge

DIN EN 12828: "Expansion vessels are to be maintained on an annual basis. The inlet gas pressure  $p_0$  is to be checked with a fitting while waterless and corrected if necessary."

- Inlet pressure tester up to about 9 bar



### Cap valve

- Secured shut-off for maintenance and dismantling of expansion vessels
- With drainage
- According to DIN EN 12828
- 10 bar/120 °C



Type	Art. No.	Weight [kg]
Digital pressure gauge	9119198	0.06
Flowjet G ¾"	9116799	0.24
Wall mounting bracket with clamping strap	7611000	0.22
AG connection set AG 1"	9119204	0.85
AG connection set AG 1 ¼"	9119205	1.00
AG connection set AG 1 ½"	9119206	1.15
Cap valve SU R ¾" x ¾"	7613000	0.26
Cap valve SU R 1" x 1"	7613100	0.57
Bladder rupture detector MBM II	7857700	0.62

# Selection and calculation

## Pressures in the system

Applies to expansion vessels in hot water heating systems

### Excess pressures

- $p_{st}$  = static pressure
- $p_0$  = minimum operating pressure
- $p_a$  = supply pressure
- $p_e$  = final pressure
- $p_{sv}$  = safety valve actuating pressure

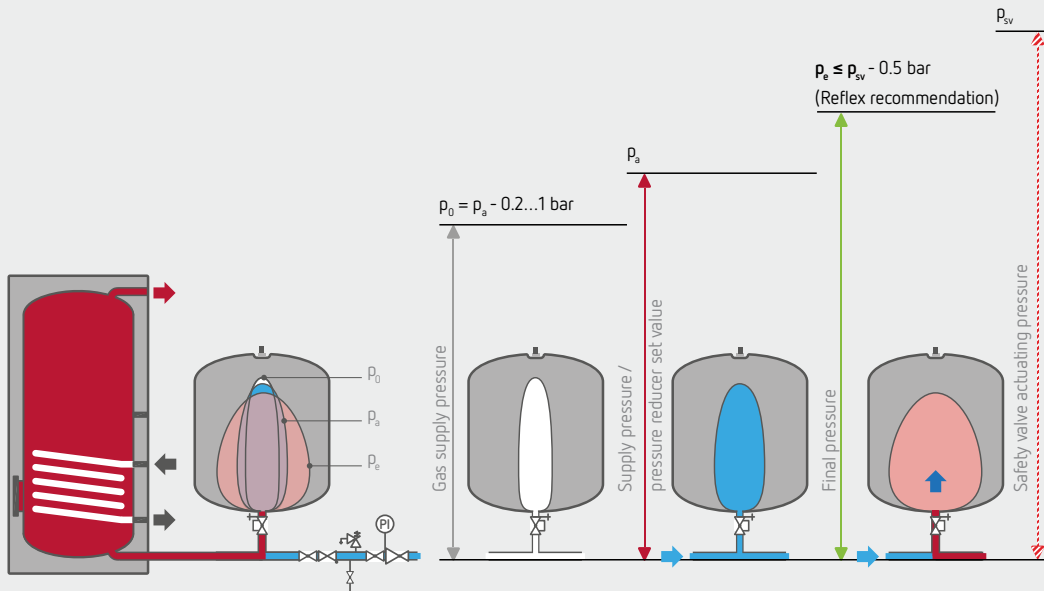

### Application limits according to DVGW

The following design parameters in accordance with DIN 4708 part 5 are decisive when using MAG-W:

Potable water heater capacity	$V_{Sp}$ in l
Nominal volume of the MAG-W	$V_n$ in l
Safety valve actuating pressure	$p_{sv} = 6.0 \text{ or } 10.0 \text{ bar}$
Working pressure differential	$d_{pA} = 20\% \text{ of } p_{sv} \text{ in bar}$
Facility pressure ( $p_e = p_{sv} - d_{pA}$ )	$p_e = 4.8 \text{ or } 8.0 \text{ bar}$
Supply pressure in the MAG-W	$p_0 = p_a - 0.2 \text{ in bar}$
Supply pressure $p_a$	$p_a$ in bar
(idle pressure behind the pressure reducer)	
Cold water temperature	$t_w = 10^\circ\text{C constant}$
Hot water temperature	$t_{ww} = 60^\circ\text{C constant}$
Water expansion	$n = 1.67\%$

## Refix quick selection

### Selection by nominal volume $V_n$

- 10 °C Cold water feed temperature
- 60 °C Vessel temperature

- Gas supply pressure  $p_0 = 3.0 \text{ bar}$
- Pressure reducer preset pressure  $p_a \geq 3.2 \text{ bar}$

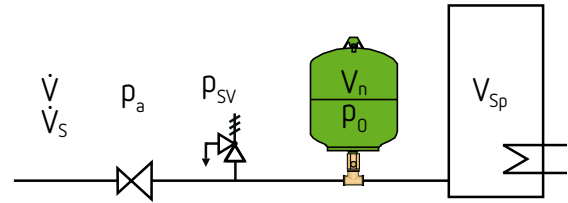

- Gas supply pressure  $p_0 = 4.0 \text{ bar}$  = standard
- Pressure reducer preset pressure  $p_a \geq 4.2 \text{ bar}$

### Refix quick selection

$p_{sv}$ [bar]	6	7	8	10
$V_{sp}$ [litres]	$V_n$ Refix nominal volume [litres]			
90	8	8	8	8
100	8	8	8	8
120	8	8	8	8
130	8	8	8	8
150	8	8	8	8
180	12	8	8	8
200	12	12	8	8
250	12	12	12	8
300	18	18	12	12
400	25	18	18	18
500	25	25	18	18
600	33	25	25	18
700	33	33	25	25
800	60	33	33	25
900	60	60	33	25
1.000	60	60	33	33
1.500	80	80	60	60
2.000	100	100	80	80
3.000	100	100	100	100

$p_{sv}$ [bar]	6	7	8	10
$V_{sp}$ [litres]	$V_n$ Refix nominal volume [litres]			
90	8	8	8	8
100	12	8	8	8
120	12	8	8	8
130	12	8	8	8
150	18	12	8	8
180	18	12	8	8
200	18	12	12	8
250	25	18	12	12
300	25	18	18	12
400	33	33	15	25
500	60	33	25	25
600	60	60	33	25
700	60	60	33	25
800	80	80	60	25
900	80	60	60	33
1.000	100	60	60	60
1.500	200	100	80	60
2.000	200	200	100	80
3.000	300	200	200	100

## Selection example

Vessel volume ( $V_{sp}$ ) **900 litres**  
 Hot water temperature ( $T_{wh}$ ) **60 °C**  
 Pressure reducer  
 preset pressure ( $p_a$ ) **4.2 bar**

Safety valve ( $p_{sv}$ ) **10.0 bar**  
 Expansion (60 °C/10 °C) ( $n$ ) **1.7%**  
 Supply pressure ( $p_0$ ) **4.0 bar**

Vessel volume ( $V_n$ ) **31.5 litres**



**Selection by peak volume flow  $\dot{V}_s$**

In potable water expansion vessels with **flow-through**, determining just the nominal volume  $V_n$  is not enough. Further checks are to be carried out to establish whether the maximum recommended peak volume flow  $\dot{V}_s$  has not been exceeded as well as the pressure drop  $\Delta p$ .

Once the nominal volume of the Reflex has been selected, checks must be carried out on vessels with flow-through to establish whether the peak volume flow  $\dot{V}_s$ , resulting from the calculation of the pipe network in accordance with DIN 1988 can be implemented on the Reflex vessels. If a larger nominal connection diameter is required, for Reflex DD, a 60 litre Reflex DT is to be used instead of the 8–33 litre vessel for greater flow.

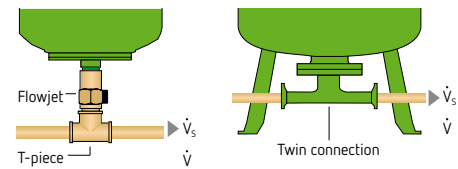

- 10 °C Cold water feed temperature
- 60 °C Vessel temperature

Available connections		Recommended max. peak volume flow $\dot{V}_s^*$	Actual pressure drop at volume flow $\dot{V}$
<b>Reflex DD</b>		<b>8 – 33 Liter</b>	
With or without Flowjet	Rp 3/4" = standard	$\leq 2.5 \text{ m}^3/\text{h}$	$\Delta p = 0.03 \text{ bar} \times \left(\frac{\dot{V} \text{ m}^3/\text{h}}{2.5 \text{ m}^3/\text{h}}\right)^2$
T-piece bore	Rp 1" (on site)	$\leq 4.2 \text{ m}^3/\text{h}$	negligible
<b>Reflex DT</b>	<b>60 – 500 Liter</b>		
with Flowjet Rp 1 1/4"		$\leq 7.2 \text{ m}^3/\text{h}$	$\Delta p = 0.04 \text{ bar} \times \left(\frac{\dot{V} \text{ m}^3/\text{h}}{7.2 \text{ m}^3/\text{h}}\right)^2$
<b>Reflex DT</b>	<b>80 – 3,000 Liter</b>		
Twin connection DN 50		$\leq 15 \text{ m}^3/\text{h}$	$\Delta p = 0.14 \text{ bar} \times \left(\frac{\dot{V} \text{ m}^3/\text{h}}{15 \text{ m}^3/\text{h}}\right)^2$
Twin connection DN 65		$\leq 27 \text{ m}^3/\text{h}$	$\Delta p = 0.11 \text{ bar} \times \left(\frac{\dot{V} \text{ m}^3/\text{h}}{27 \text{ m}^3/\text{h}}\right)^2$
Twin connection DN 80		$\leq 36 \text{ m}^3/\text{h}$	negligible
Twin connection DN 100		$\leq 56 \text{ m}^3/\text{h}$	negligible
<b>Reflex DE, DC</b> (no flow-through)		unlimited	$\Delta p = 0$

\* Determined at a speed of 2 m/s.

## Comprehensive calculation and design notes

Potable water is a food stuff. Expansion vessels in potable water installations therefore have to meet specific requirements to DIN 4807 part 5. Only vessels with flow-through are permitted.

### Refix in water heating systems

#### Calculation

The calculation is completed in accordance with DIN 4807 part 5, see next page.

#### Circuit

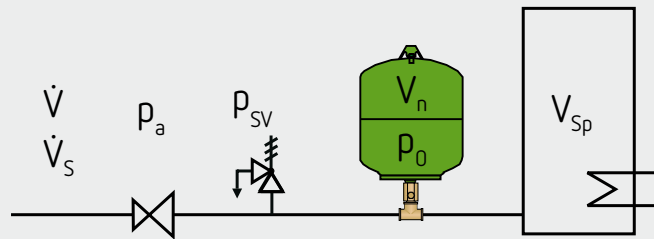

The safety valve is usually installed directly at the cold water inlet on the water heater. On Refix DD and DT, the safety valve may also be installed immediately upstream of the flow through, shut-off and drain valve when viewed from the direction of flow if the following conditions are met:

<b>Refix DD with T-piece:</b>	Rp 3/4"	max. 200 l water heater
	Rp 1"	max. 1,000 l water heater
<b>Refix DT flow-through fitting:</b>	Rp 1 1/4"	max. 5,000 l water heater

#### Material values $n, p_0$

Usually determined between cold water temperature 10 °C and maximum hot water temperature 60 °C.

#### Thermal disinfection

With thermal disinfection, the entire hot water network is heated to > 70 °C. As expansion vessels are installed in the cold water feed, they are not affected by the increased temperature. If thermal disinfection is included, this must only be included in the calculation.

#### Supply pressure $p_0$ , minimum operating pressure

The minimum operating pressure or supply pressure  $p_0$  in the expansion vessel must be at least 0.2 bar less than the minimum flow pressure. Depending on the distance between the pressure reducer and the Refix, supply pressure settings of 0.2 to 1.0 bar less than the preset pressure on the pressure reducer are required.

#### Supply pressure $p_a$

This is identical to the preset pressure on the pressure reducer. Pressure reducers to DIN 4807 part 5 are required in order to achieve a stable supply pressure and therefore the full capacity of the Refix.

#### Expansion vessel

In potable water systems to DIN 1988, only Refix vessels with flow-through to DIN 4807 part 5 may be used. Refix with a connection may be used for non-potable water.

<b>Initial data</b>		see manufacturer's specifications / proxy values for calculation	
Vessel volume	$V_{sp}$ [l]		
Heat output	$\dot{Q}_w$ [kW]		
Water temperature	$t_{ww}$ [°C]	Depending on the controller setting 50 ... 60 °C	
Percentage expansion	[%]		$n = \dots\%$
Pressure reducer	$p_a$ [bar]	Setting pressure	$p_a = \dots \text{ bar}$
Safety valve	$p_{sv}$ [bar]	<b>Reflex recommendation 10 bar</b>	$p_{sv} = \dots \text{ bar}$
Peak flow	$\dot{V}_s$ [m³/h]		$\dot{V}_s = \dots [\text{m}^3/\text{h}]$

<b>Selection by nominal volume <math>V_n</math></b>			
Supply pressure	$p_0$ [bar]	$p_0 = p_a - (0.2 \dots 1.0 \text{ bar})$ Set supply pressure 0.2 ... 1.0 bar less than pressure reducer (depending on distance between pressure reducer and Reflex)	$p_0 = \dots \text{ bar}$
Nominal volume	$V_n$ [l]	$V_n = V_{sp} \times \frac{n \times (p_{sv} + 0.5) (p_a + 1.2)}{100 \times (p_0 + 1) (p_{sv} - p_0 - 0.7)}$	$V_n = \dots \text{ litres}$

**Selection by peak volume  $\dot{V}_s$**

Once the nominal volume of the Reflex has been selected, checks must be carried out on vessels with flow-through to establish whether the peak volume flow  $\dot{V}_s$ , resulting from the calculation of the pipe network in accordance with DIN 1988 can be implemented on the Reflex vessels. If this is the case, for Reflex DD, a 60 litre Reflex DT is to be used instead of the 8–33 litre vessel for greater flow. Alternatively, a Reflex DD with a suitably larger T-piece can be used whereby it should be noted that the flow-through insert of the DD vessel protrudes into the full bore of the T-piece.

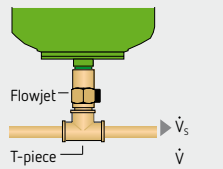
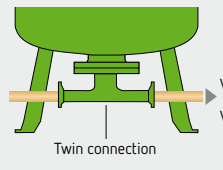
	Rec. max. peak volume flow $\dot{V}_s^*$	Actual pressure loss at volume flow $\dot{V}$	
<b>Reflex DD 8–33 litres</b> with or without Flowjet T-piece bore Rp ¾" = standard T-piece Rp 1" (on site)	$\leq 2.5 \text{ m}^3/\text{h}$ $\leq 4.2 \text{ m}^3/\text{h}$	$\Delta p = 0.03 \text{ bar} \times \left( \frac{\dot{V}_{p_0} [\text{m}^3/\text{h}]}{2.5 \text{ m}^3/\text{h}} \right)^2$ negligible	
<b>Reflex DT 60–500 Liter</b> with Flowjet Rp 1¼"	$\leq 7.2 \text{ m}^3/\text{h}$	$\Delta p = 0.04 \text{ bar} \times \left( \frac{\dot{V} [\text{m}^3/\text{h}]}{7.2 \text{ m}^3/\text{h}} \right)^2$	
<b>Reflex DT 80 – 3.000 litres</b>			
Twin connection DN 50	$\leq 15 \text{ m}^3/\text{h}$	$\Delta p = 0.14 \text{ bar} \times \left( \frac{\dot{V} [\text{m}^3/\text{h}]}{15 \text{ m}^3/\text{h}} \right)^2$	
Twin connection DN 65	$\leq 27 \text{ m}^3/\text{h}$	$\Delta p = 0.11 \text{ bar} \times \left( \frac{\dot{V} [\text{m}^3/\text{h}]}{27 \text{ m}^3/\text{h}} \right)^2$	
Twin connection DN 80	$\leq 36 \text{ m}^3/\text{h}$	negligible	
Twin connection DN 100	$\leq 56 \text{ m}^3/\text{h}$	negligible	
<b>Reflex DC</b> (No flow-through)	unlimited	$\Delta p = 0$	

$\Delta p = \dots \text{ bar}$   
 $G = \dots$

**Result**

Reflex DT5 ..... l	$V_n = \dots \text{ l}$
Reflex DD ..... l G = ..... (Standard Rp ¾" incl.)	$p_0 = \dots \text{ bar}$
Reflex DT5 ..... l	

## Refix in pressure booster systems

Potable water is a food stuff. Expansion vessels in potable water installations therefore have to meet specific requirements to DIN 4807 part 5. Only vessels with flow-through are permitted.

### Calculation

The calculation is completed in accordance with DIN 1988 part 5, Codes of practice for drinking water installations, pressure boosting and pressure reduction.

### Circuit

Refix in pressure booster systems  
Suction side

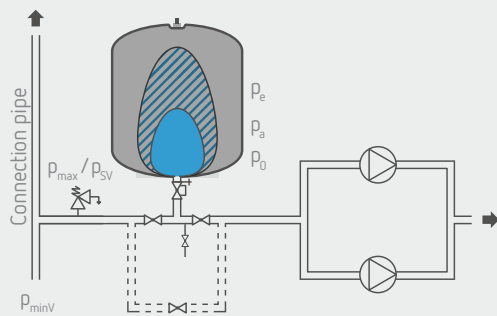

On the **upstream side of a pressure boosting system (DEA)**, Refix expansion vessels relieve the pressure on the connection pipe and the supply network. Installation is to be agreed with the water supply company.

Refix in pressure booster systems  
Pressure side

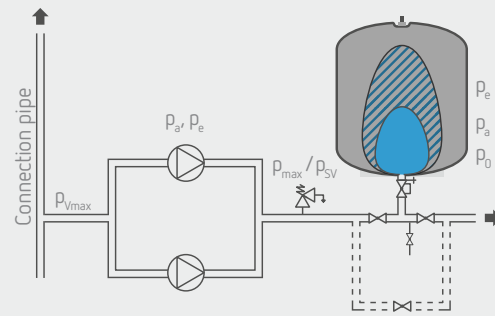

On the **downstream side of a pressure booster system (DEA)** the switching frequency is reduced when installing Refix, particularly in cascade controlled systems. Installation on both sides of the DEA may be necessary.

### Supply pressure $p_0$ , supply pressure $p_a$

The minimum operating pressure or the supply pressure  $p_0$  in the Refix must be set to approximately 0.5 to 1 bar less than the minimum supply pressure when installed on the suction side and 0.5 to 1 bar less than the cut-in pressure on the pressure side of a DEA. As the supply pressure  $p_a$  is at least 0.5 bar greater than the supply pressure, there is always an adequate water reservoir available which is an important precondition for low-wear operation.

In potable water systems to DIN 1988, only Refix vessels with flow-through to DIN 4807 part 5 may be used. Refix with a connection may be used for non-potable water.



Care should be taken to ensure the pressure surges do not exceed the maximum permissible operating pressure.

**Suction side circuit: Refix on the upstream side of the DEA**

Installation is to be agreed with the relevant water supply company. This is necessary if the following criteria cannot be met:

- if a pump fails in the DEA, the flow speed in the connection pipe of the DEA may not alter by more than 0.15 m/s
- if all the pumps fail, by not more than 0.5 m/s
- when the pump is in operation, the minimum supply pressure  $p_{\min V}$  may not drop below 50 % and must be at least 1 bar

Initial data		see manufacturer's specifications / proxy values for calculation			
min. supply pressure		Selection in accordance with DIN 1988 part 5			$V_n = \dots$ litres
max. feed flow	$p_{\min V}$ [bar]	max. feed flow $V_{\max P}$ / m <sup>3</sup> /h	Refix DT with twin connection $V_n$ / litre	Refix DT $V_n$ / litre	
	$\dot{V}_{\max P}$ [m <sup>3</sup> /h]	≤ 7	300	300	
		> 7 ≤ 15	500	600	
		> 15	---	800	
Supply pressure	$p_0$ [bar]	$p_0 = p_{\min V} - 0.5$ bar			$p_0 = \dots$ bar
Result					
Refix DT5	..... l	$V_n = \dots$ l			
with twin connection DN 50		$p_0 = \dots$ bar			
Refix DT5	..... l				

**Pressure side circuit Refix on the downstream side of the DEA**

Initial data		see manufacturer's specifications / proxy values for calculation			
For limiting the switching frequency in pressure-controlled systems					
Max. pump head for the DEA	$H_{\max}$ [mWs]				
Max. supply pressure	$p_{\max}$ [bar]				
Cut-in pressure	$p_E$ [bar]	s - Switching frequency 1/h	20	15	10
Cut-out pressure	$p_A$ [bar]				
Max. feed flow	$\dot{V}_{\max P}$ [l/h]				
Switching frequency	s [1/h]	Pump output	kW	≤ 4,0	≤ 7,5
No. of pumps	n [pieces]				
Electrical power of the more powerful pump	$P_{el}$ [kW]				
Nominal volume	$V_n$ [l]	$V_n = 0,33 \times V_{\max P} \frac{p_A + 1}{(p_A - p_E) \times s \times n}$			$V_n = \dots$ litres
For storing the minimum feed quantity $V_e$ between On and Off for the DEA					
Cut-in pressure	$p_E$ [bar]				$p_0 = \dots$ bar
Cut-out pressure	$p_A$ [bar]				
Refix supply pressure	$p_0$ [bar]	Reflex recommendation: for $p_0 = p_E - 0,5$ bar			
Feed quantity	$V_e$ [l]				
Nominal volume	$V_n$ [l]	$V_n = V_e \frac{(p_E + 1)(p_A + 1)}{(p_0 + 1)(p_A - p_E)}$			$V_n = \dots$ litres
Check permissible operating excess pressure	$p_{\max}$ [bar]	$p_{\max} = \leq 1,1 p_{zul} \frac{H_{\max} [\text{mWs}]}{10}$			$p_{\max} = \dots$ bar
Initial data					
Refix DT5	..... l	$V_n = \dots$ l			
with twin connection DN 50		$V_n = \dots$ l			
Refix DT5	..... l	$p_0 = \dots$ bar			

# Installation examples

## Reflex in water heating systems – installation examples

Reflex DD, DT 60–500 with Flowjet flow through, shut-off and drain valve

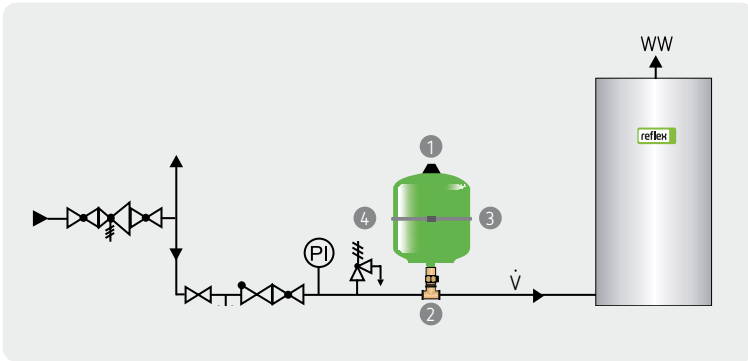

- The **complete solution** with Flowjet flow through, shut-off and drain valve
- **Benefits:** Flowjet is easy to fit and DIN-compliant  
Guaranteed shut off, drainage and flow-through for Reflex.
  - ① Reflex DD or Reflex DT 60–500
  - ② Flowjet flow through, shut-off and drain valve optional accessory for Reflex DD:
    - standard with T-piece Rp 3/4",  $V \leq 2.5 \text{ m}^3/\text{h}$
    - for T-piece Rp 1"  $V \leq 4.2 \text{ m}^3/\text{h}$
 for Reflex DT 60–500' with Flowjet:
    - standard with Rp 1 1/4"  $V \leq 7.2 \text{ m}^3/\text{h}$
  - ③ Reflex wall-hung holder for 8–25 litres (33 l with butt straps, DT with feet)
  - ④ A safety valve may also be fitted upstream in the direction of flow of the Reflex DD or the DT5 with Flowjet provided the nominal diameter of the required  $S_v \leq$  than the downstream storage feed.

Reflex DD without Flowjet flow through, shut-off and drain valve

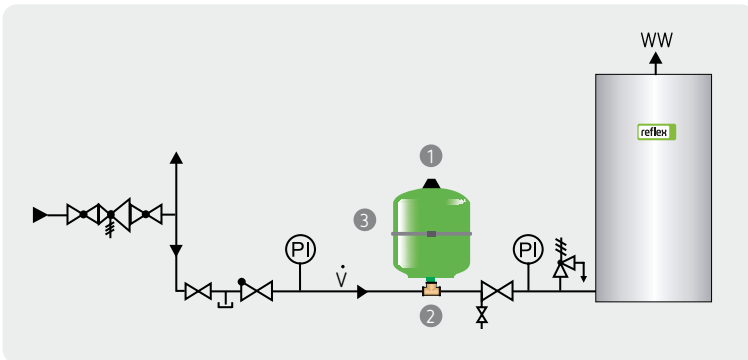

- If no Flowjet flow through, shut-off and drain valve is fitted, the feed to the water heater must be shut-off during maintenance work and the Reflex DD drained via an on-site fitting.
  - ① Reflex DD
  - ② T-piece Rp 3/4",  $V \leq 2.5 \text{ m}^3/\text{h}$   
For T-piece Rp 1"  $V \leq 4.2 \text{ m}^3/\text{h}$
  - ③ Reflex wall-hung holder for 8–25 litres (33 l with butt straps feet)

Reflex DT with twin connection

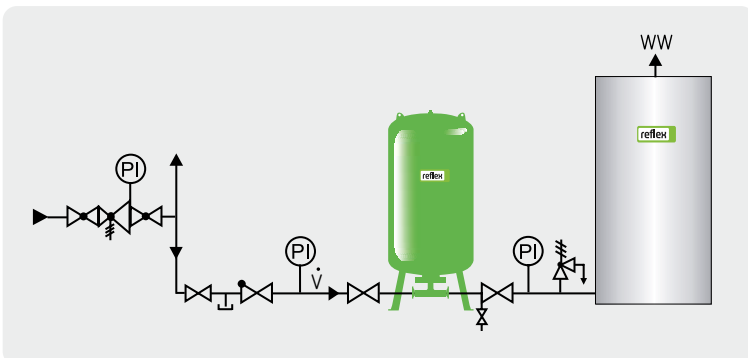

- Additional fittings are required when shutting off and draining the Reflex DT with twin connection.
- The safety valve can not be shut off at the cold water inlet on the vessel.



Vessel charging systems are sometimes subjected to high temperatures. Please contact your Reflex representative.

# Operation & Maintenance

Industrial Safety Regulations require expansion vessels to be checked on an annual basis. The relevant notes for installers and operators in the Reflex Assembly, Operating and Maintenance Instructions are to be observed.

## 1. Visual inspection

- Inspect vessel for damage, corrosion, etc.  
In the event of damage, complete repairs or replace and determine the possible cause.
- Match vessel suitability to on-site use.

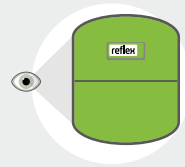

## 2. Check bladder

Briefly activate the gas filling valve. If water leaks out:

- For vessels which do not have a facility for replacing the bladder, replace the expansion vessel.
- for vessels which have a facility for replacing the bladder, replace the bladder or alternatively contact Reflex Service for further advice.

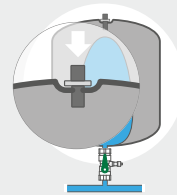

## 3. Setting gas supply pressure

Isolate the Reflex vessel from the system using the cap valve (Flowjet) and empty on the water side.

Measure supply pressure  $p_0$  at the gas filling valve and if necessary reset to the required minimum operating pressure for the system.

$$p_0 [\text{bar}] = p_s - 0.2 \text{ bar}^*$$

\* At greater distances (pressure loss) to the pressure reducer, increase the difference to  $p_s$  to up to 1 bar.

- If the pressure is too high, blow off the gas with the gas filling valve.
- If the pressure is too low, refill with nitrogen from a pressurised container.
- Enter the reset or corrected supply pressure  $p_0$  on the type plate.

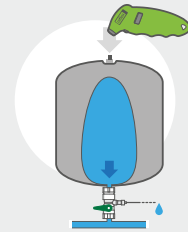

## 4. Functional inspection during operation

- Close drain at the cap valve and carefully open cap valve (Flowjet).
- Checking gas pressure during operation  
the gas pressure must now be the same as the system pressure (compare with pressure gauge on the pressure reducer) then the vessel is operational.
- If the vessel has heated up, the pressure in the vessel may be approximately 0.5 bar less than the safety valve actuating pressure.

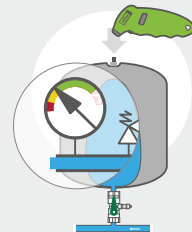

## 5. Gas filling valve leak test

Remove optional aids for filling and measuring at the gas filling valve and inspect with leak test spray to see whether the gas filling valve leaks after use. Finally, refit the cap valve, which provides the seal, on the gas filling valve.

→ The Reflex expansion vessel is now ready to be used again.

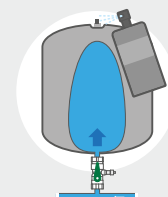



# Reflex added value

## Our digital services



### Reflex Solutions Pro—

#### Complete product solutions quickly and easily

The next generation of the proven configuration tool allows products from the entire Reflex portfolio to be individually compiled and configured to suit a specific system, irrespective of size—from a single-family home to residential buildings and

industrial premises. Whether a single product or a complete system, just choose the application, then enter the relevant system parameters, Reflex Solutions Pro works out the appropriate configuration quickly and precisely. With one click, you can download the complete documentation such as product data, tender texts and BIM data.

Start designing your configuration now for free:

 [rsp.reflex.de/en](https://rsp.reflex.de/en)

## Reflex Training — expertise gives us the edge



Close to our headquarters in Ahlen, professional craftsmen, planners and operators gear up to meet the challenges posed by heating and hot water supply in modern building technology. From installation and planning to consulting and technical operation, the Reflex Training Centre and its team aligns its programme to those partners who want to learn more about technology, standards and service from the horse's mouth. Newly acquired expertise is put

into practice, refined and experienced straight away on Reflex systems in a former manor house that has been refurbished to modern-day standards in the German region of Westphalia. Realistic simulations and a comprehensive portfolio of systems help to put the content learned to practical use, skilfully combining theory with practical aspects. The Reflex4Experts training courses are now also available online, for example, as webinars for PC, tablet or smartphone, and include short, interesting learning units on current and exciting topics that can be easily followed in the office, at home or on the road.

More information is available at [www.reflex4experts.com/en](http://www.reflex4experts.com/en)

Reflex Training Center

+49 2382 7069-9581  
[seminare@reflex.de](mailto:seminare@reflex.de)



## Our performance promise — Reflex After-Sales & Service

Supply technology systems are becoming increasingly complex. This is true for the technology as well for documentation and testing requirements. With Reflex After-Sales & Service, you remain in good hands after your purchase. Our years of expertise specialising in the Reflex product world ensure the full safety and functionality of your system.

- Expertise and many years of experience with all Reflex products
- Qualified personnel with expertise in the latest products and guidelines

- Compliance with statutory regulations and therefore also with liability and warranty provisions
- Systems optimally adapted for maximum efficiency and functionality



You can find more information about all our services at [www.reflex-winkelmann.com/int/services-downloads/after-sales-service](http://www.reflex-winkelmann.com/int/services-downloads/after-sales-service)



### Our products impress with their quality

We are confident of our product quality and therefore, since 01/01/2020, we have automatically given our customers a 5-year warranty on our heat exchangers, expansion vessels, separators and hot water storage tanks.

Heat exchangers get a warranty extension to 5 years. This does not cover faults in the installation that lead to premature wear or reduced function, such as:

- Calcification of the connection pipes and plate channels
- Corrosion due to leakage current
- Significant deviations from the water quality requirements specified in the instructions



Factory service centre

+49 2382 7069-9505  
aftersales@reflex.de



Technical hotline

+49 2382 7069-9546  
aftersales@reflex.de



Commercial processing

+49 2382 7069-7505  
aftersales@reflex.de



