

Note that all unique customer requirements (i.e tolerance) need to be verified thru Alfa Laval.

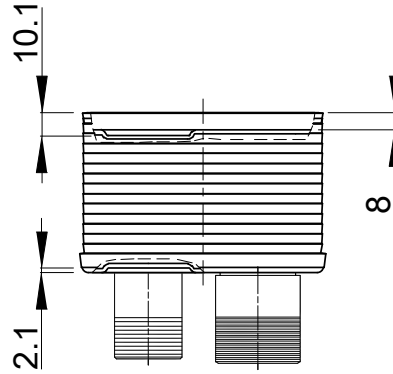
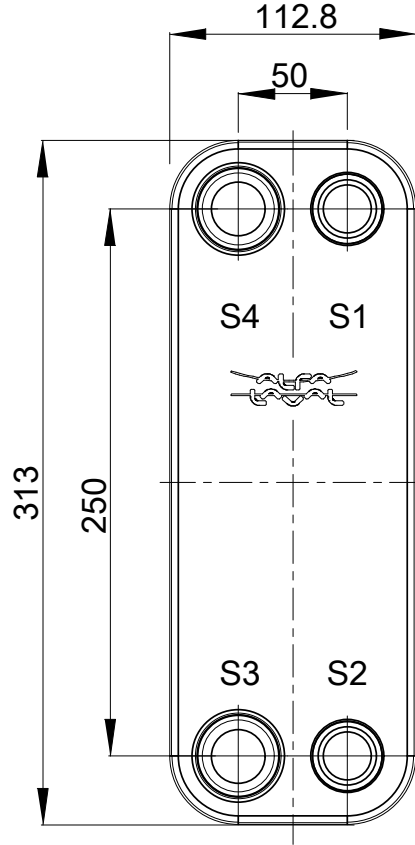
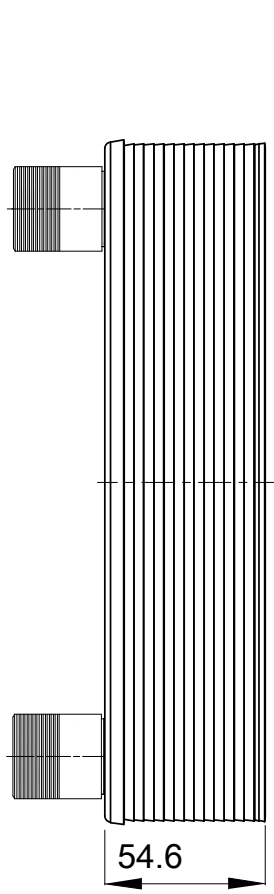
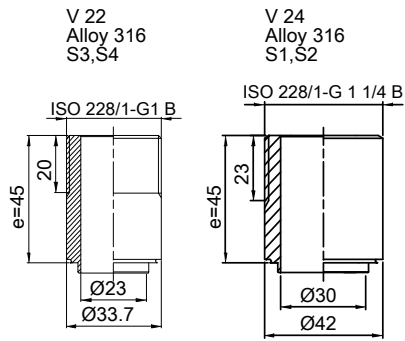

HEATING SURFACE
 NETWEIGHT 4.42 kg
 OPERATING WEIGHT
 PLATE MATERIAL Alloy 316
 PLATE GROUPING 1*8H/1*9H

T1 T2 T3 T4 locations on back side correspond to S1 S2 S3 S4 on front side

ALL DIMENSIONS IN MILLIMETERS

SIDE	MEDIA	INLET	TEMP.	OUTLET	TEMP.	FLOW RATE	PRESSURE DROP	LIQUID VOL.
1								0.43 dm ³
2								0.49 dm ³



PRESSURE VESSEL APPROVAL PED
 CB30-18H (3287083287)

www.alfalaval.com

CUSTOMER NAME / REF. NO.
 COMPANY / REF.

TOTAL LENGTH 99.6 mm
 TOTAL WIDTH 113.0 mm
 TOTAL HEIGHT 313.0 mm

6/22/2017
 REV 0