

Note that all unique customer requirements (i.e tolerance) need to be verified thru Alfa Laval.

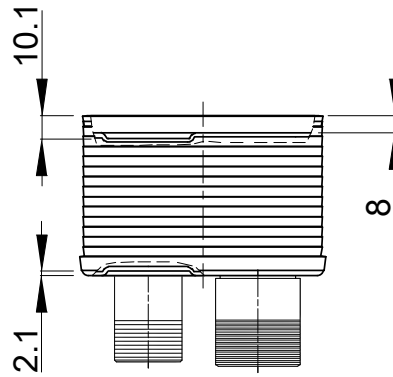
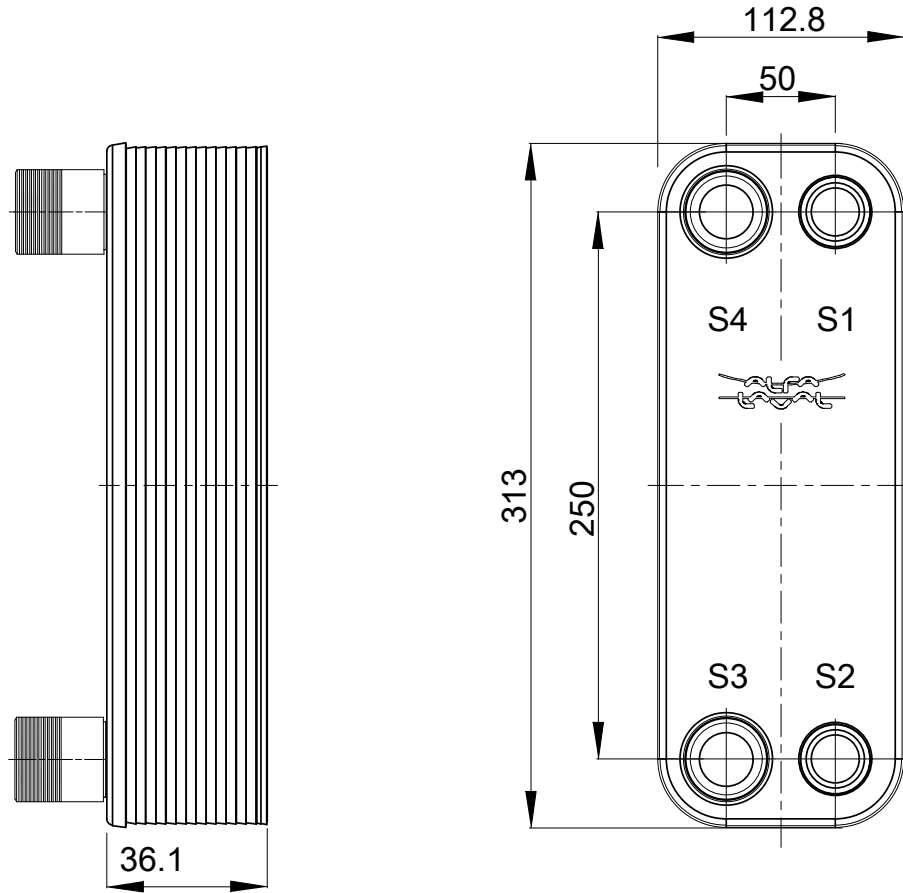
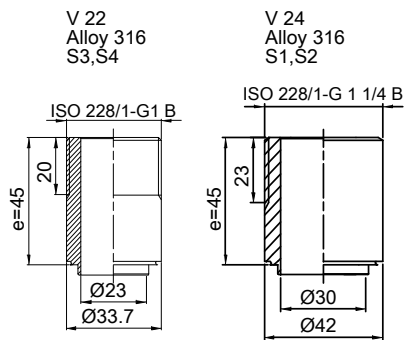

HEATING SURFACE
NETWEIGHT 3.53 kg
OPERATING WEIGHT
PLATE MATERIAL Alloy 316
PLATE GROUPING 1*4H/1*5H

T1 T2 T3 T4 locations on back side
correspond to S1 S2 S3 S4 on front side

ALL DIMENSIONS IN MILLIMETERS

SIDE	MEDIA	INLET	TEMP.	OUTLET	TEMP.	FLOW RATE	PRESSURE DROP	LIQUID VOL.
1								0.22 dm ³
2								0.27 dm ³



PRESSURE VESSEL APPROVAL
CB30-10H (3287083361)

PED

www.alfalaval.com

CUSTOMER NAME / REF. NO.

TOTAL LENGTH 81.1 mm
TOTAL WIDTH 113.0 mm
TOTAL HEIGHT 313.0 mm

COMPANY / REF.

6/22/2017
REV 0