

Note that all unique customer requirements (i.e tolerance) need to be verified thru Alfa Laval.

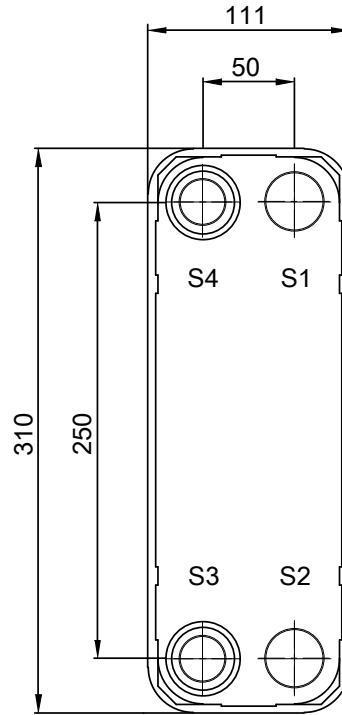
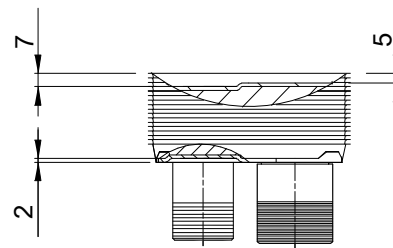
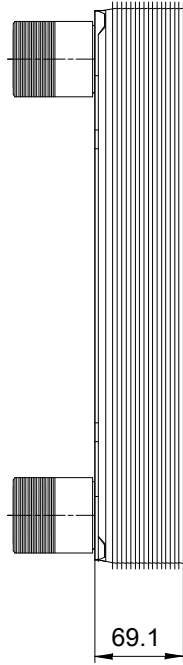
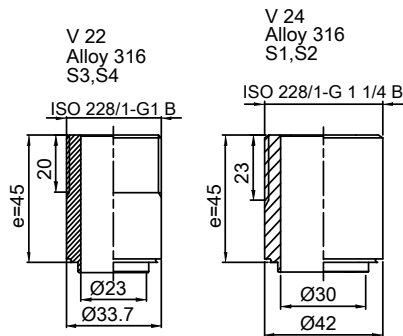

HEATING SURFACE
 NETWEIGHT 4.90 kg
 OPERATING WEIGHT
 PLATE MATERIAL Alloy 316
 PLATE GROUPING 1*11H/1*12H

Frameplate is depressed 2 mm at connection S3/S4
 Pressureplate is depressed 2 mm / even number of channel plates
 at connections T3/T4 / uneven number of channel plates at
 connections T1/T2.

T1 T2 T3 T4 locations on back side
 correspond to S1 S2 S3 S4 on front side

ALL DIMENSIONS IN MILLIMETERS

SIDE	MEDIA	INLET	TEMP.	OUTLET	TEMP.	FLOW RATE	PRESSURE DROP	LIQUID VOL.
1								0.55 dm ³
2								0.6 dm ³

PRESSURE VESSEL APPROVAL PED

AlfaNova 27-24H (3288000901)

www.alfalaval.com

CUSTOMER NAME / REF. NO.

TOTAL LENGTH 114.1 mm
 TOTAL WIDTH 111.0 mm
 TOTAL HEIGHT 310.0 mm

COMPANY / REF.

8/6/2021
 REV 0