

FRAME PLATE

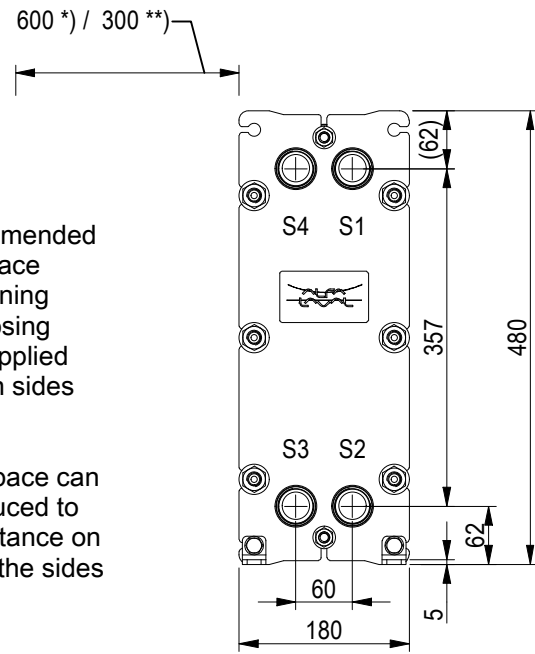

*) Recommended free space for opening and closing to be applied on both sides

**) Free space can be reduced to this distance on one of the sides

Space between pressure plate and supporting column should be kept free from fixed installations!

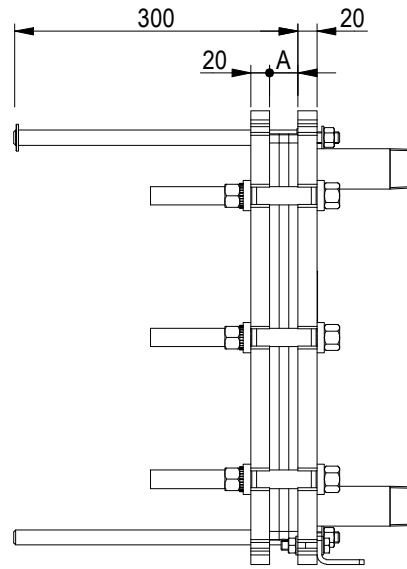

PRESSURE PLATE (MOVABLE)

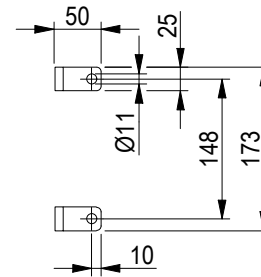
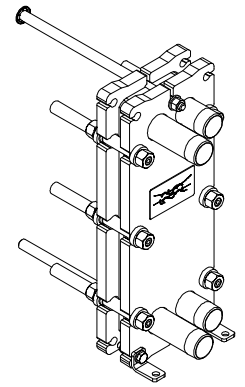
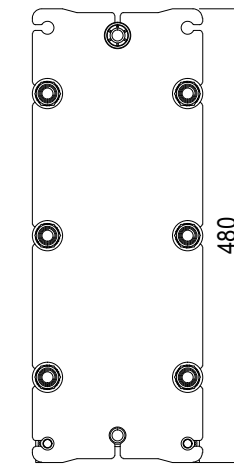

ISO 7 - R 1 1/4, ALLOY 316, 80 mm
S1, S2

A-A:

ISO 7 - R 1 1/4, ALLOY 316, 120 mm
S3, S4

C-C:

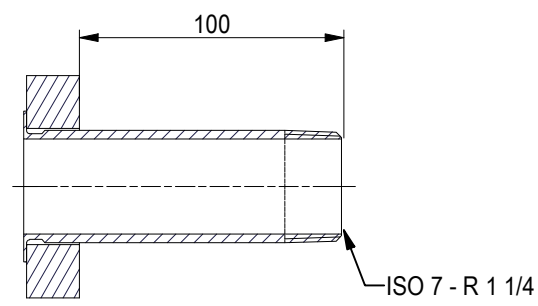
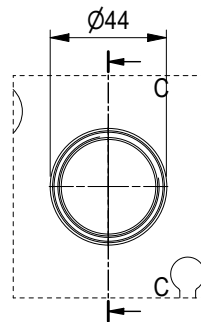
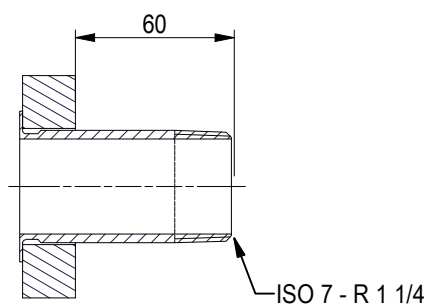
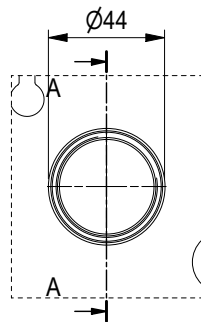

All dimensions in millimeters (mm)

NO. OF UNITS

1

APPROX. OUTER DIMENSIONS	
LENGTH	310 mm
WIDTH	190 mm
HEIGHT	490 mm
APPROX. WEIGHTS	
NET WEIGHT, EMPTY	33.3 kg
WEIGHT FULL OF WATER	35.8 kg
PLATE MATERIAL	ALLOY 316
PLATE THICKNESS	0.5 mm
GASKET	NBRP Clip-on

CHANNEL ARRANGEMENT 1*12 H
/ 1*12 H



www.alfalaval.com

DRAWING
GASKETED PLATE HEAT EXCHANGER

M3-FG

PED Article 4.3

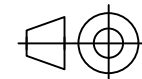

8240121692

Do not use this drawing for foundation bolting or piping layout

DATE 2/22/22
REVISION 0